

Touch Screen Computer Kiosk Installation Instruction Manual



Installation Diagram for Touch Screen Kiosk



1. Prepare a piece of foam board or soft surface, to pad the machine body.



2. Lay the kiosk on the foam board.



3. Take out the base and place it on the bottom of the body.



4. Put the screws into the screw holes of the base.



5. Tighten the screws with the provided hex wrench.



6. Erect the kiosk to complete the installation.

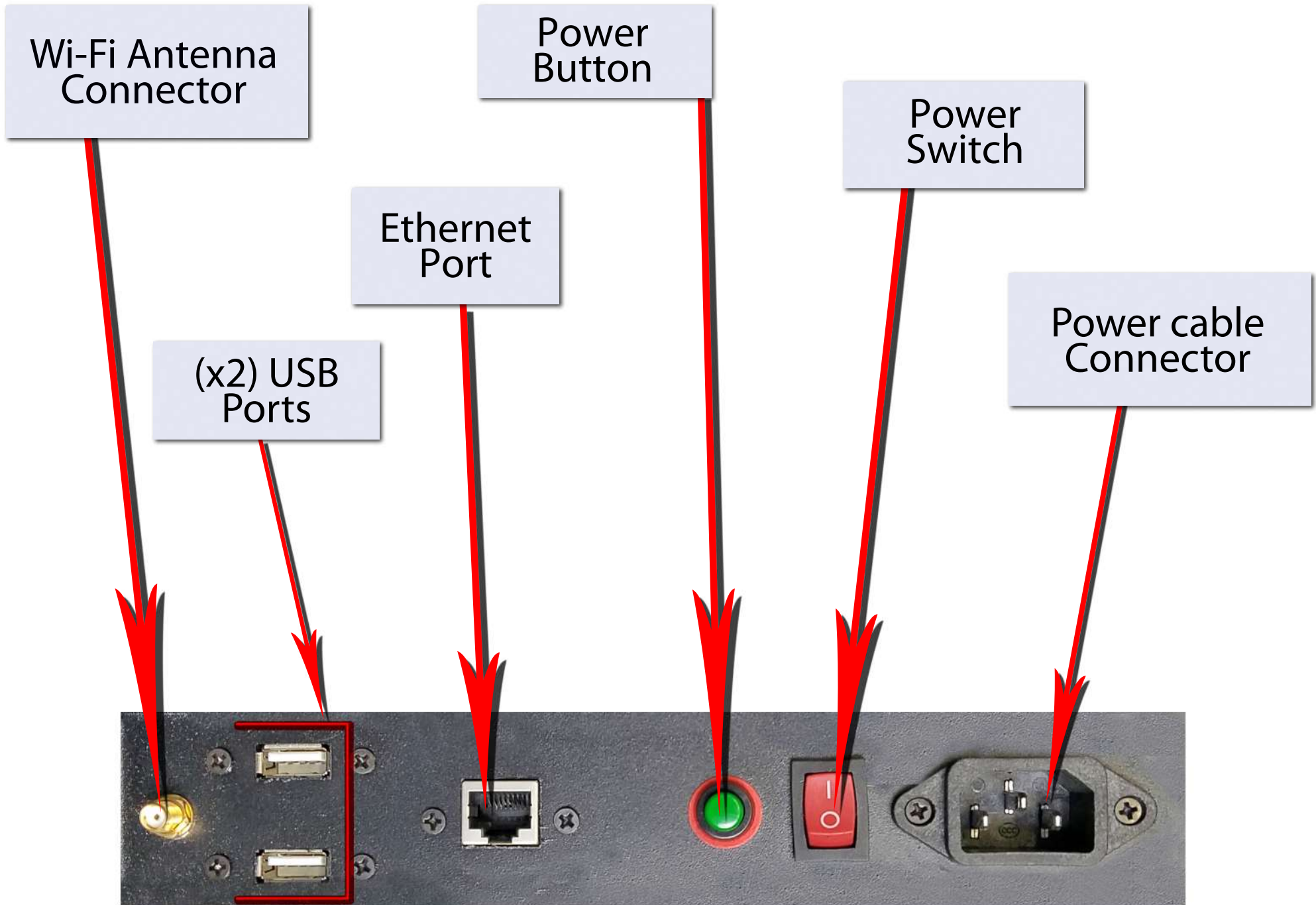

Step #1: Plug in the power cable into the connector

Step #2: Flip the power switch to **on** position

Step #3: Press on the power button to turn on the Kiosk

Start Menu

Account

Click to switch to another account, lock the computer, or sign out

Named Groups

Tiles are organized into groups

Live Tiles

Click a tile to open an app

Most frequently used apps

File Explorer Settings Power All Apps

Start button

Click here to open the Start menu









Cortana

Search for apps, files, or folders by typing in keywords, or saying the terms you're looking for



Keyboard shortcuts

Basic Commands

Start Menu	 + Q
Copy a Folder/File	Ctrl + C
Cut a Folder/File	Ctrl + X
Paste a Folder/File	Ctrl + V
Cortana (speech)	 + C
Cortana (text)	 + S
Actions Center	 + A
Task View	 + Tab
Close App	Alt + F4
Lock computer	 + L
Print	Ctrl + P
File Explorer	 + E
Run dialog box	 + R





Start Menu

- **To Open the Start Menu:** Click the **Start** button. Or, press .
- **To Resize App Tile on the Start Menu:** Right-click a tile, click **Size** and select a size.
- **To Rearrange Tiles:** Tiles are organized into groups of related apps. Drag a tile to a new location in a group, or drag it between groups to start a new group.
- **To Remove a Tile from the Start Menu:** Right-click the tile and click **Unpin from Start**.
- **To Add a Tile to the Start Menu:** Right-click the app and select **Pin to Start**.
- **To Stop Updating an App's Live Tile:** Right-click an app's tile and click **Turn live tile off**.
- **To Search for Files or Apps:** Click within the Search field and type a keyword for the file or app. Search results are displayed in the menu.
- **To Rename Live Tile Groups:** Click the Live Tile group's name, and type in a new name.
- **To Lock Your Computer:** Click the **Account** button and select **Lock**.
- **To Sign Out of Windows:** Click the **Account** button and select **Sign Out**.
- **To Switch Users:** Click the **Account** button and select another user account.
- **To Change Account Settings:** Click the **Account** button and select **Change Account Settings**.









Apps

- **To Launch an App:** Find and click the app's tile on the Start menu. Or, select **All Apps** from the Start Menu and select the app you want to open.
- **Jump to Different Apps:** In the **All Apps** list click a letter header, then select another letter, to display all of the apps that begin with that letter.
- **To Search for an App:** Click within the Search field and type a keyword for the app.
- **To View All Installed Apps:** Select **All Apps** from the Start Menu.
- **To Close an App:** Click the **Close** button in the top-right corner of the app. Or, press **Alt + F4**.
- **To Jump to an Open App:** Click the **Task View** button. Or, press  + **Tab**. **Note:** Right-click an app and click **Close** to close it.
- **To Install an App:** Install apps from the Windows Store, media such as DVDs, or download from the Internet.
- **To Uninstall an App:** Click the **Start** button and select **Settings** from the Start Menu. Click the **System** category and select **Apps & features**. Select the app that you want to install and click the **Uninstall** button.

Settings Shortcuts

Open Settings	 + I
Devices pane	 + K
Sharing pane	 + H
Display options for second screen	 + P
Quick Link menu	 + X

Desktop shortcuts

Desktop	 + D
Maximize	 + ↑
Minimize/Restore	 + ↓
Switch between apps	Alt + Tab
Minimize all windows	 + M
Snap app to left	 + ←
Snap app to right	 + →
New Desktop	 + Ctrl + D
Close Current Desktop	 + Ctrl + F4
Switch Desktops	 + Ctrl + ←/→

Desktop

Cortana:

Click to open Cortana to search for items.

Window preview:

Point to the program icon on the taskbar. Click a preview thumbnail to view the window.

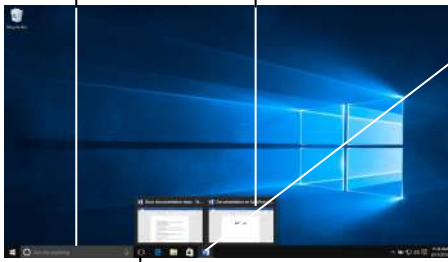

Program icon: Click to open the program. Rearrange icons by clicking and dragging.

Show Desktop button: Point or click here to make open windows invisible.

Task View button: Click to view all of the open windows in Task View.

Notification area: The Action Center, clock, and other system icons are located here.

- **To Peek at Open Windows:** Point to a program icon on the taskbar. Point at the resulting thumbnail preview to peek at the window.
- **To Minimize Other Windows:** Press **Windows** + **Home**. Or, click and shake a window's title bar quickly from side to side.
- **To Compare Windows Side by Side:** Click and drag a window's title bar to the right side of the screen, and select a window thumbnail for the left side of the screen. Or, press **Windows** + **→** or **Windows** + **←**.
- **To Maximize an Open Window:** Click the window's Maximize window. Or, press **Windows** + **↑**.
- **To Switch Between Apps:** Press **Alt** + **Tab** to move quickly between open programs and windows on the desktop. Or, press **Windows** + **Tab** to open Task View, and select a window thumbnail.
- **To Access Settings:** Click the **Start** button and select **Settings** from the Start menu.
- **To Pin a Program to the Taskbar:** Pin your favorite desktop apps to the taskbar so you can open them from within the desktop. Open the program you want to pin, right-click the program icon on the taskbar and select **Pin this program to taskbar**.

Settings and Personalization

- **To Personalize your PC:** Click the **Start** button, select **Settings** from the Start menu, and click the **Personalization** category from the Settings app.
- **Change Background** – Choose built-in colors and pictures, or use your own. Select more than one picture to start a slide show.
- **Change Colors** – Change window color and transparency.
- **Change Lock screen:** Change the image that appears when the screen is locked.
- **Change Start:** Change what apps appear on the Start Menu.
- **Change Themes:** Change Windows's color scheme.

File Explorer

Address bar

Displays the location of the folder that is currently open

Title bar

Click and drag to move the window

Search box

Enter keywords to search the folder.

Ribbon

Displays buttons and menus for common commands

Navigation Pane

Provides quick navigation to folders and files. Browse to favorite locations, libraries, OneDrive, This PC, and the network

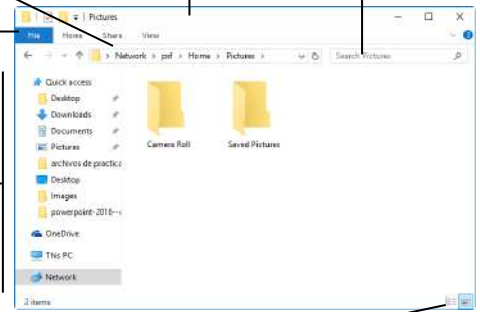

Display Settings

Choose how you want the content within the File Explorer to display

Action Center

- **To Display Notifications:** Click the **Notifications** icon on the taskbar, or swipe in from the right side of the screen on a touchscreen, to open the Notification Center.
- **Collapse Actions Center:** Click **Collapse** to collapse the actions down to only the top row. The top row can be customized in the Settings app, so you can control which four actions are available when the list is collapsed.
- Available actions include:
 - **All Settings:** Opens the Settings app.
 - **Airplane Mode:** Toggling on will turn off all radios.
 - **Battery Saver:** Toggles battery saver mode, dimming the screen and applying other settings to save power.
 - **Bluetooth:** Toggles Bluetooth radio on/off.
 - **Brightness:** Adjusts your screen's brightness between 100%, 75% 50%, and 25%.
 - **Connect:** Connects to wireless devices (ie. Bluetooth).
 - **Location:** Toggles location services on/off.
 - **Note:** Opens a new note in MS OneNote.
 - **Quiet Hours:** A Do Not Disturb mode which blocks notifications from appearing.
 - **Rotation Lock:** Locks portrait or landscape views in tablet computers.
 - **Tablet Mode:** Toggles tablet mode, which makes the computer act more like Windows 8 and includes full-screen apps, bigger touch targets, the Start Screen replaces the Start Menu, etc.
 - **VPN:** Displays VPN settings in the Settings app.
 - **WiFi:** Toggles wifi on/off (not used to find a network).

Cortana

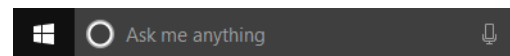

- Cortana allows you to search for apps, files, or folders by typing in keywords, or saying the terms you're looking for.
- You can use Cortana's speech recognition by clicking the microphone button and saying the terms you're looking for.
- To open Cortana, click in the Cortana field to the right of the Start button.
- Cortana will display the results that she thinks are relevant.
- You can control your search results in Cortana's Notebook.