

PARTS

(1) Hardware

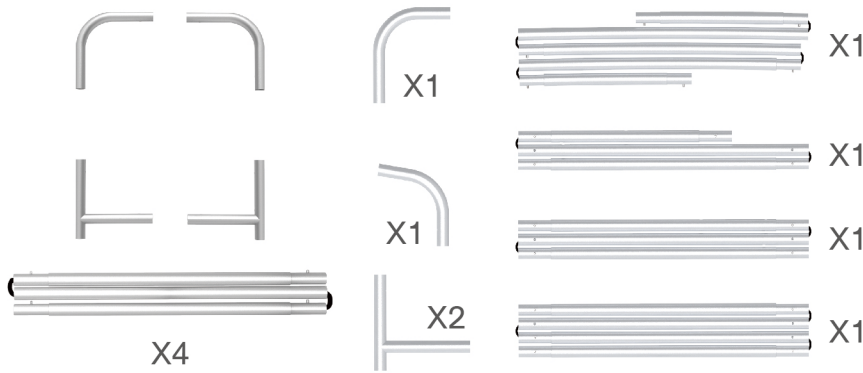

(2) Graphic printing fabric banner



STEP 01

To connect the poles according to the labellings

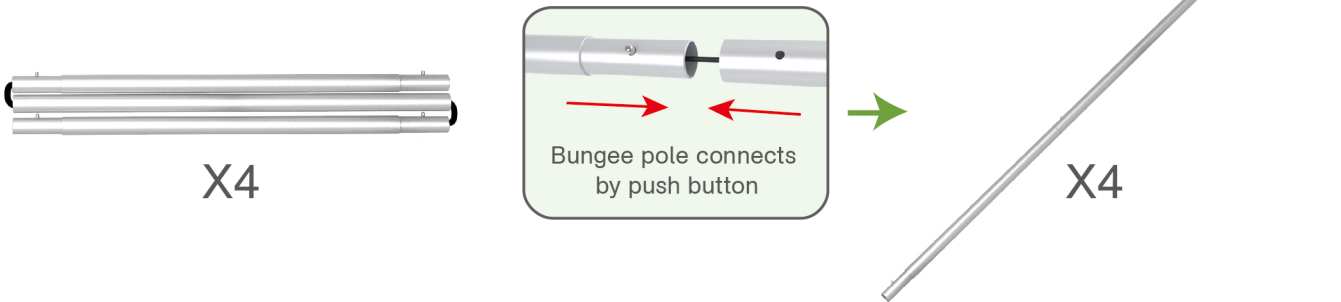

STEP 02

To connect long poles by corner pieces according to the labellings

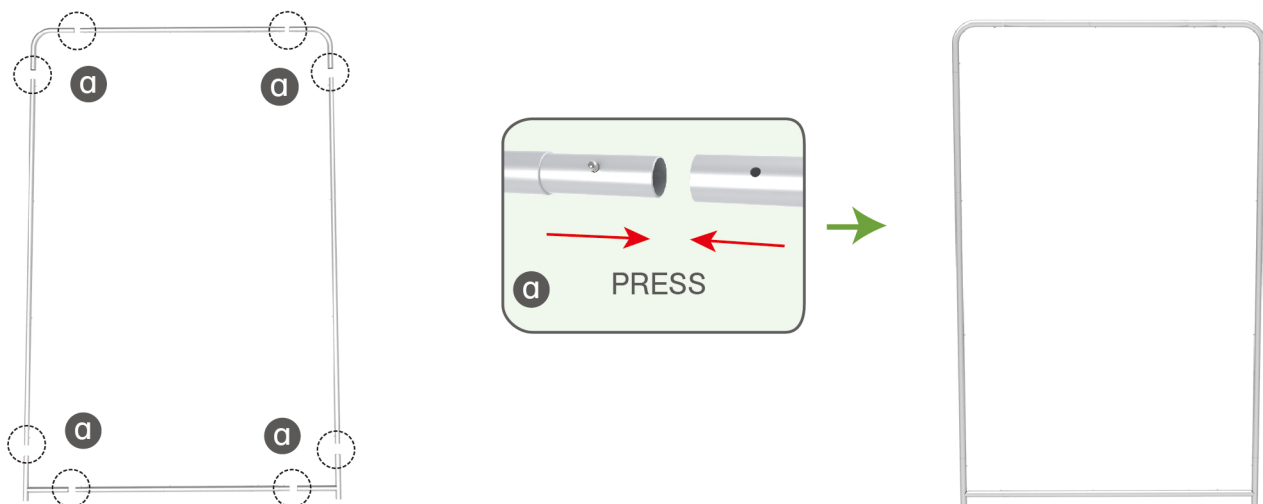

PARTS

STEP 03

To slide the fabric banner on the frame from top and zip up at bottom

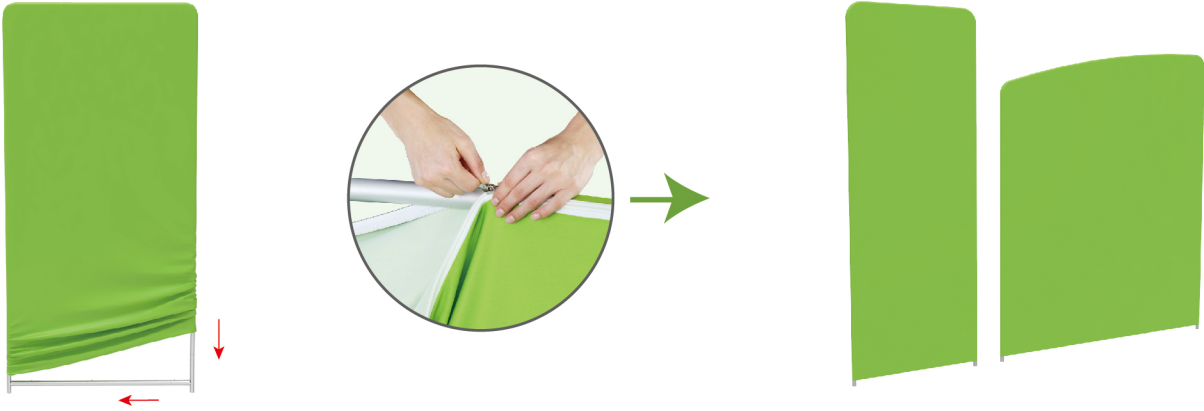

Same Steps for the rest back walls

Booth Set Assembly

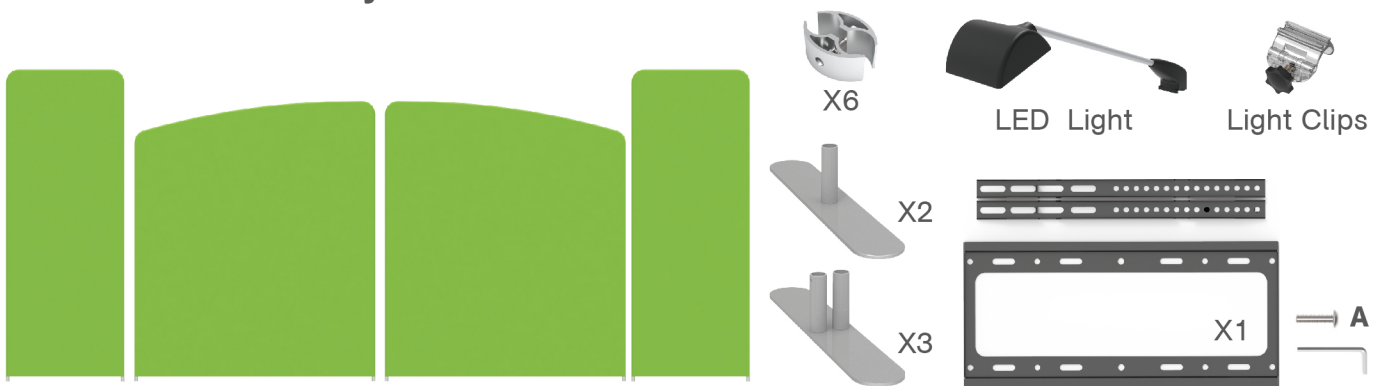

STEP 01

To assemble the stand feet in position

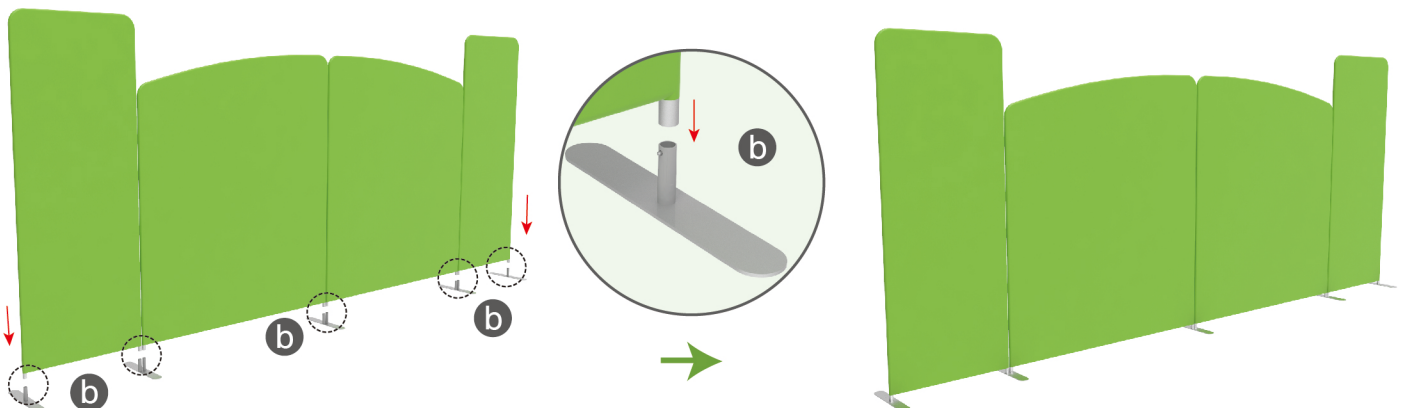

PARTS

STEP 02

To put the C clips in between display wall and fasten for standing perfectly

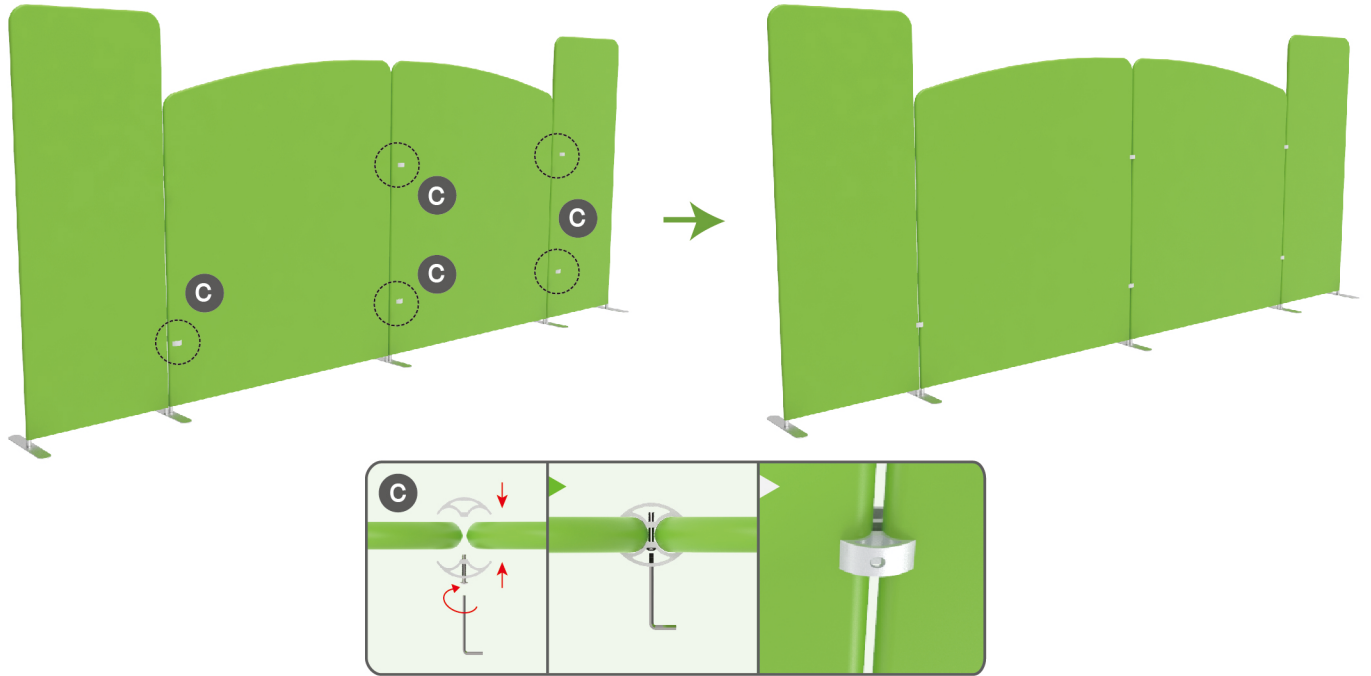

STEP 03

To install the TV mount in position

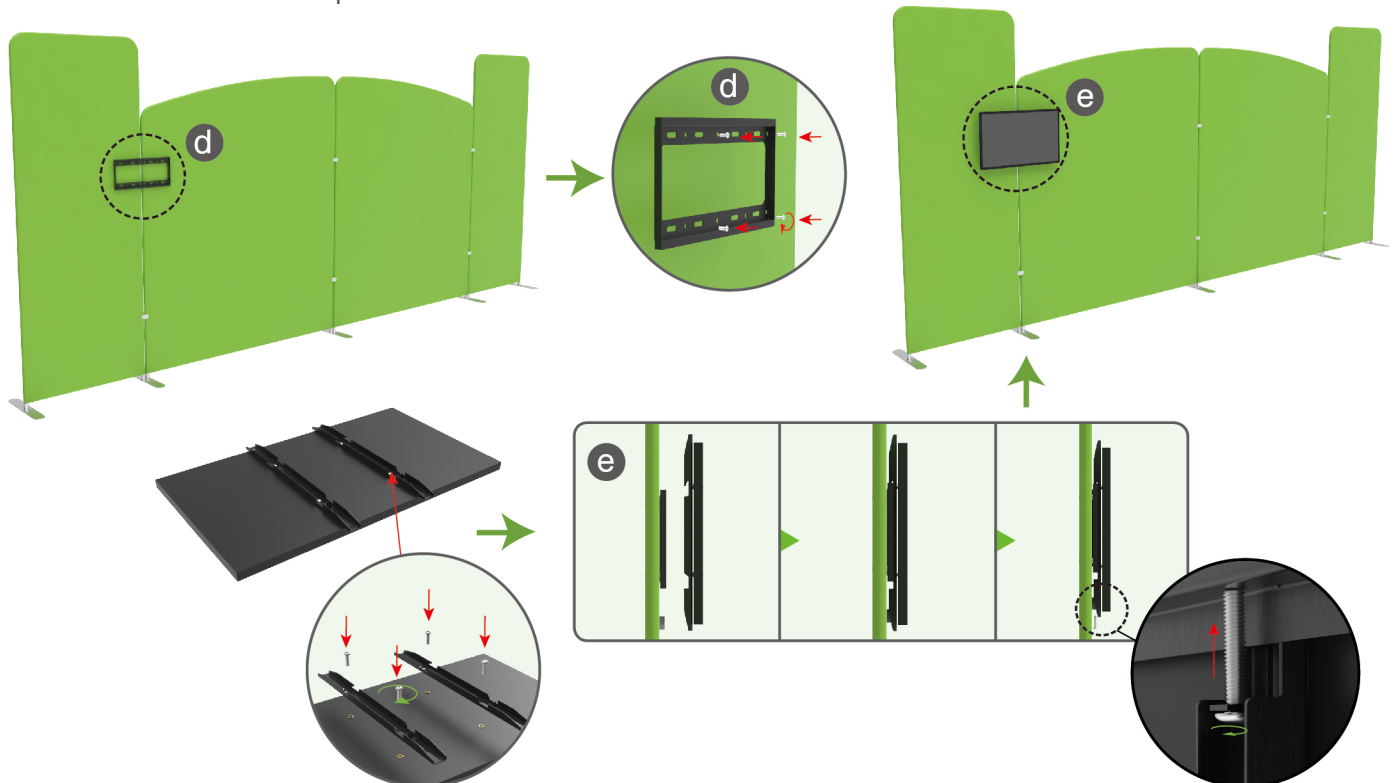

PARTS

STEP 04

Install LED light

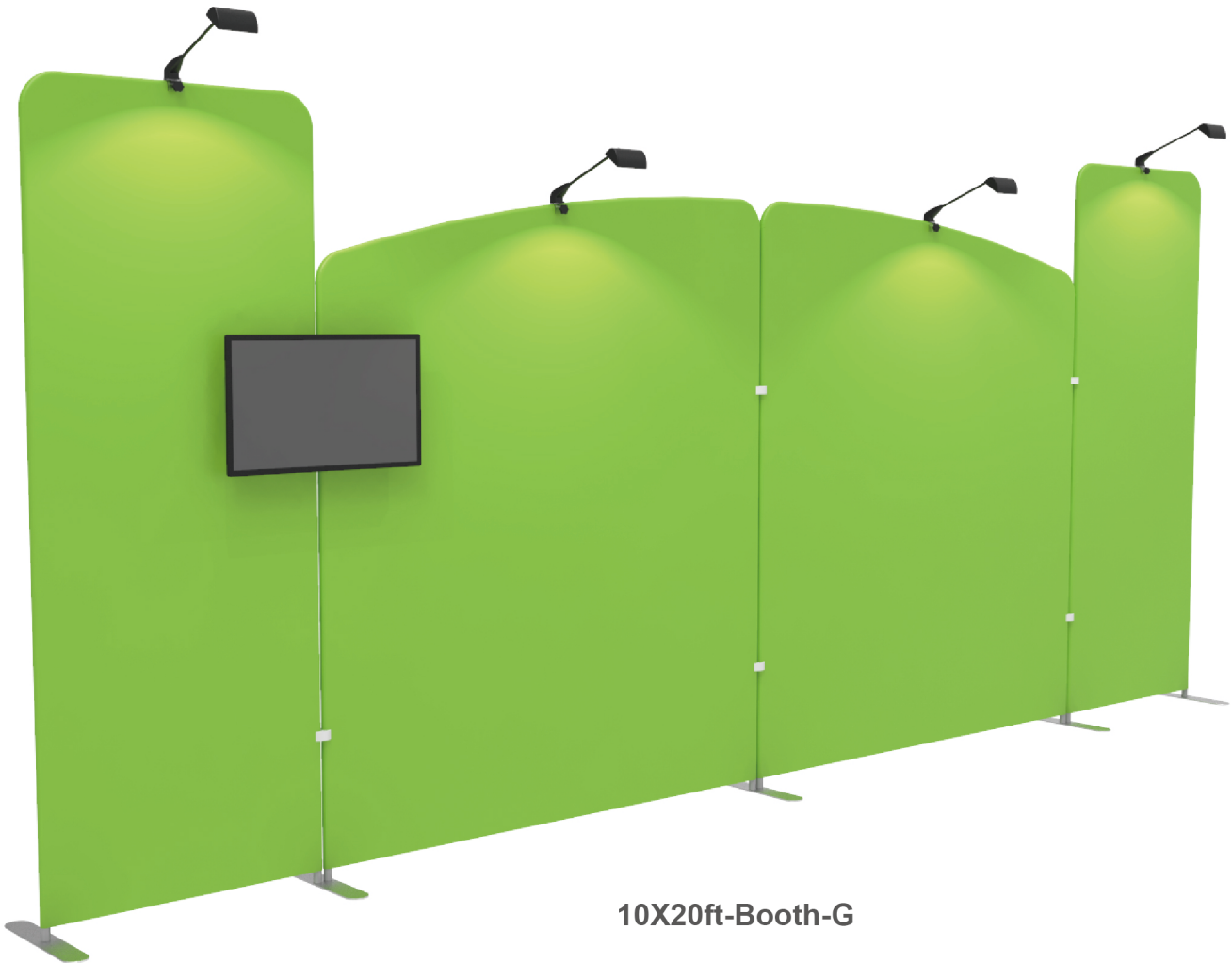
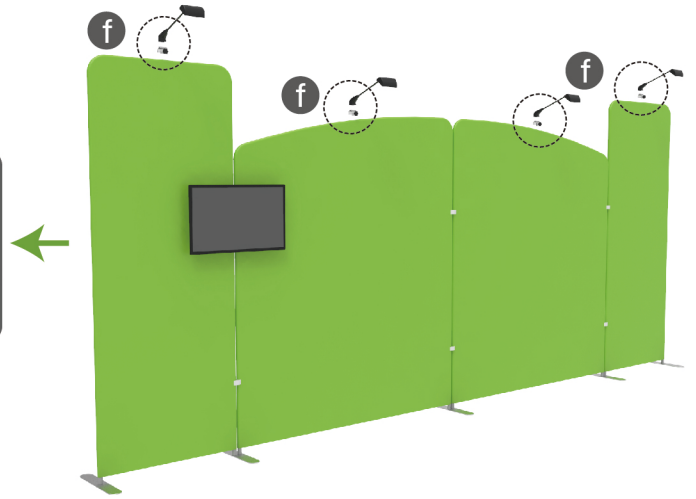
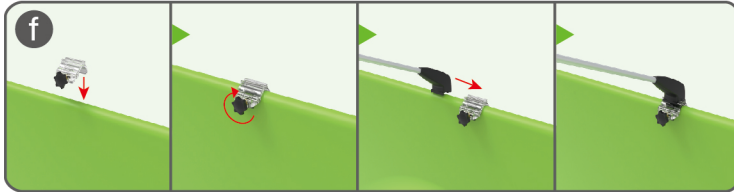

10X20ft-Booth-G