

# LINEAR 17

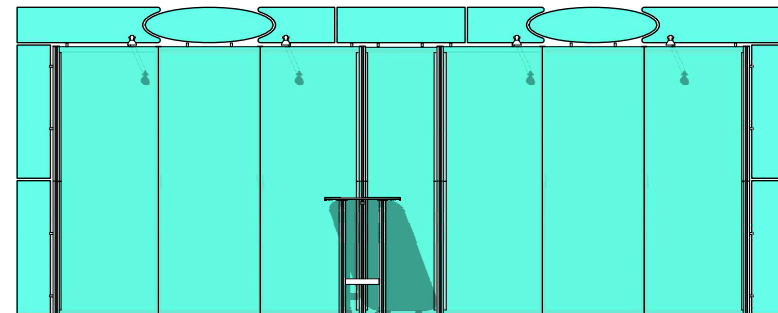

| Code | # | Description                  |
|------|---|------------------------------|
| L3   | 6 | HORIZONTAL GRAPHIC BAR       |
| L4   | 4 | VERTICAL GRAPHIC BAR WITH CE |
| L1   | 4 | BOTTOM HALF UPRIGHT          |
| L3-1 | 1 | HORIZONTAL GRAPHIC BAR       |

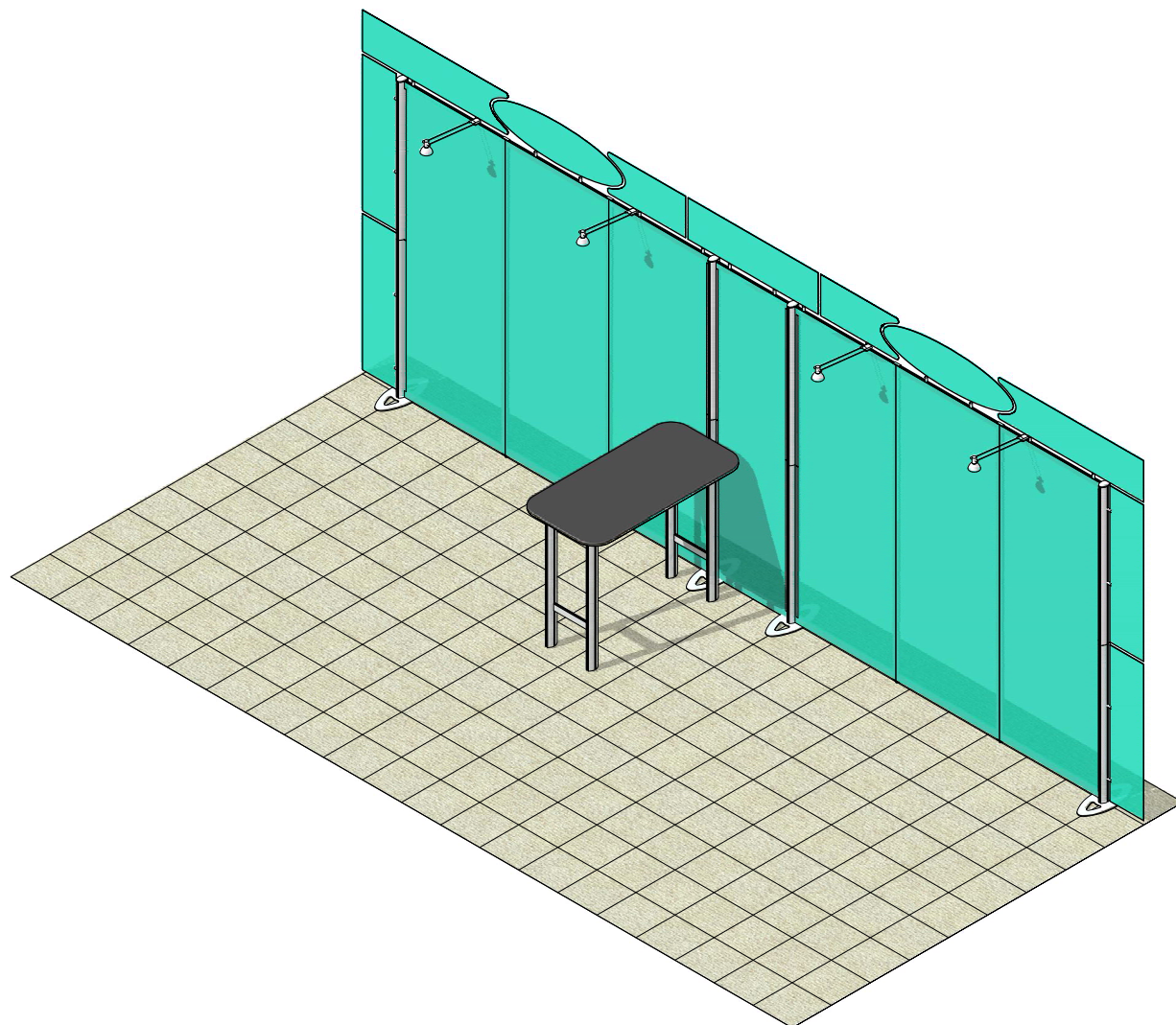
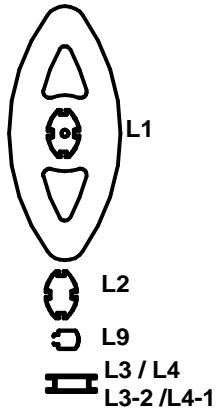

**LINEAR**

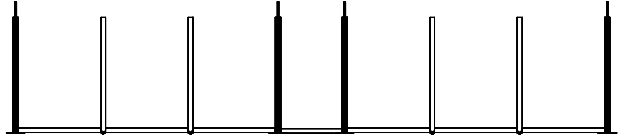
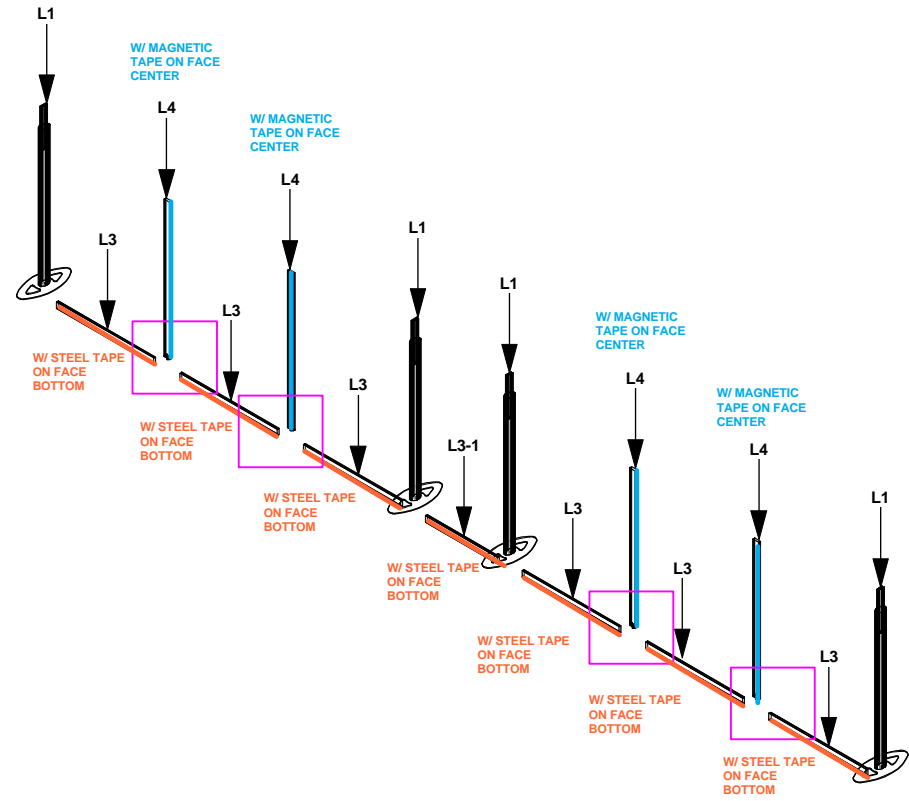
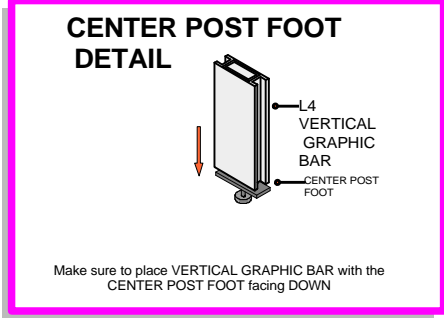
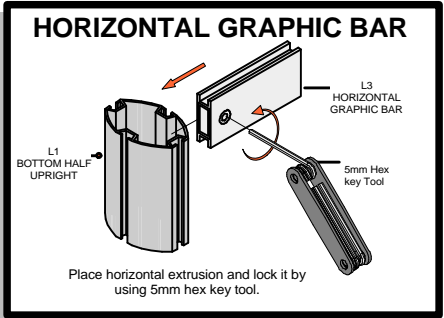
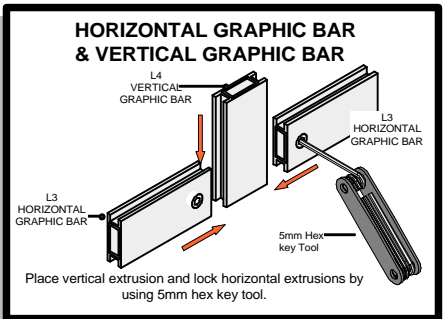

| Code        | # | Description |
|-------------|---|-------------|
| JOINER BAR  | 8 | JOINER BAR  |
| CORNER LOCK | 1 | CORNER LOCK |

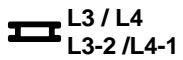
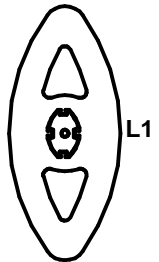
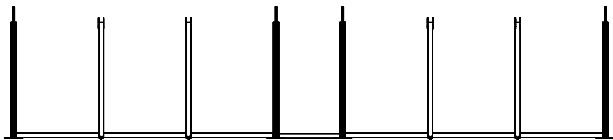
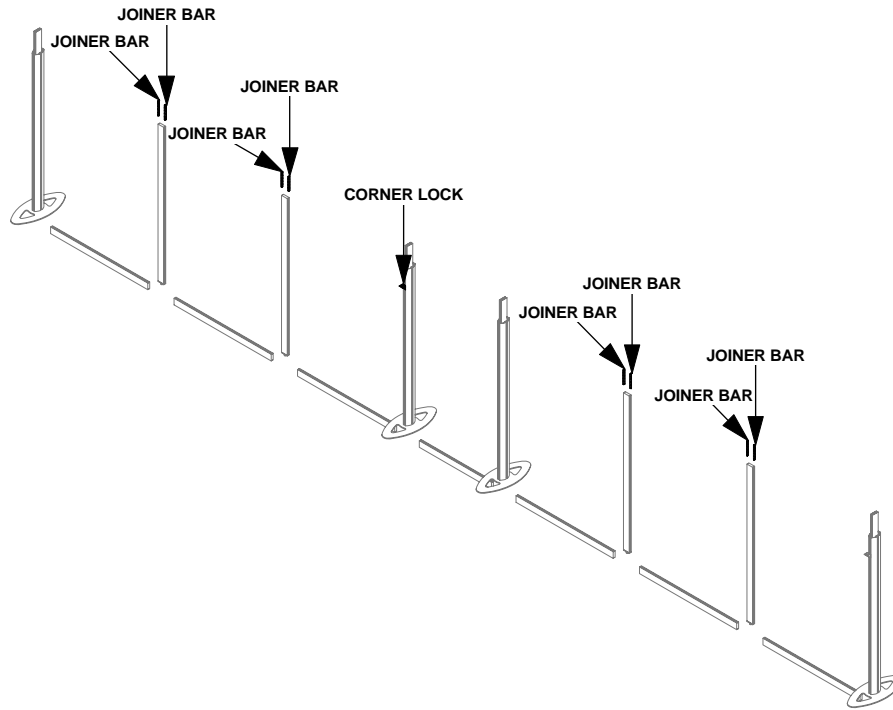
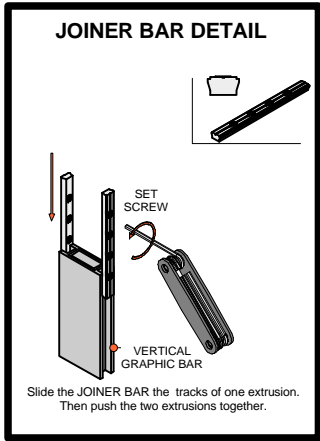
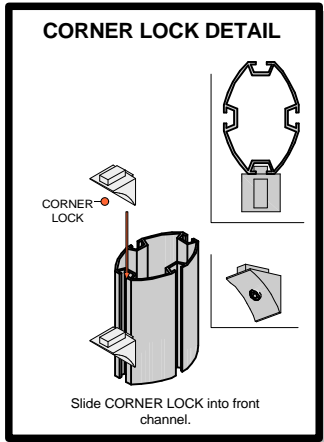
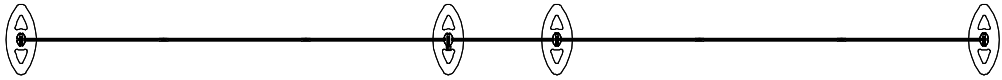

**LINEAR**

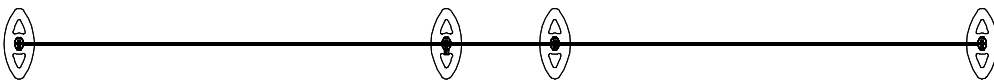

| Code  | #  | Description                  |
|-------|----|------------------------------|
| L2    | 4  | TOP HALF UPRIGHT             |
| L6    | 4  | CAP                          |
| L3    | 6  | HORIZONTAL GRAPHIC BAR       |
| L4-1  | 4  | VERTICAL GRAPHIC BAR         |
| L9    | 12 | GRAPHICS MOUNTING BAR        |
| CPH C | 4  | CAP FOR VERTICAL GRAPHIC BAR |
| L3-1  | 1  | HORIZONTAL GRAPHIC BAR       |

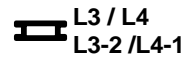
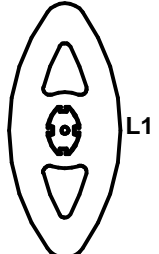
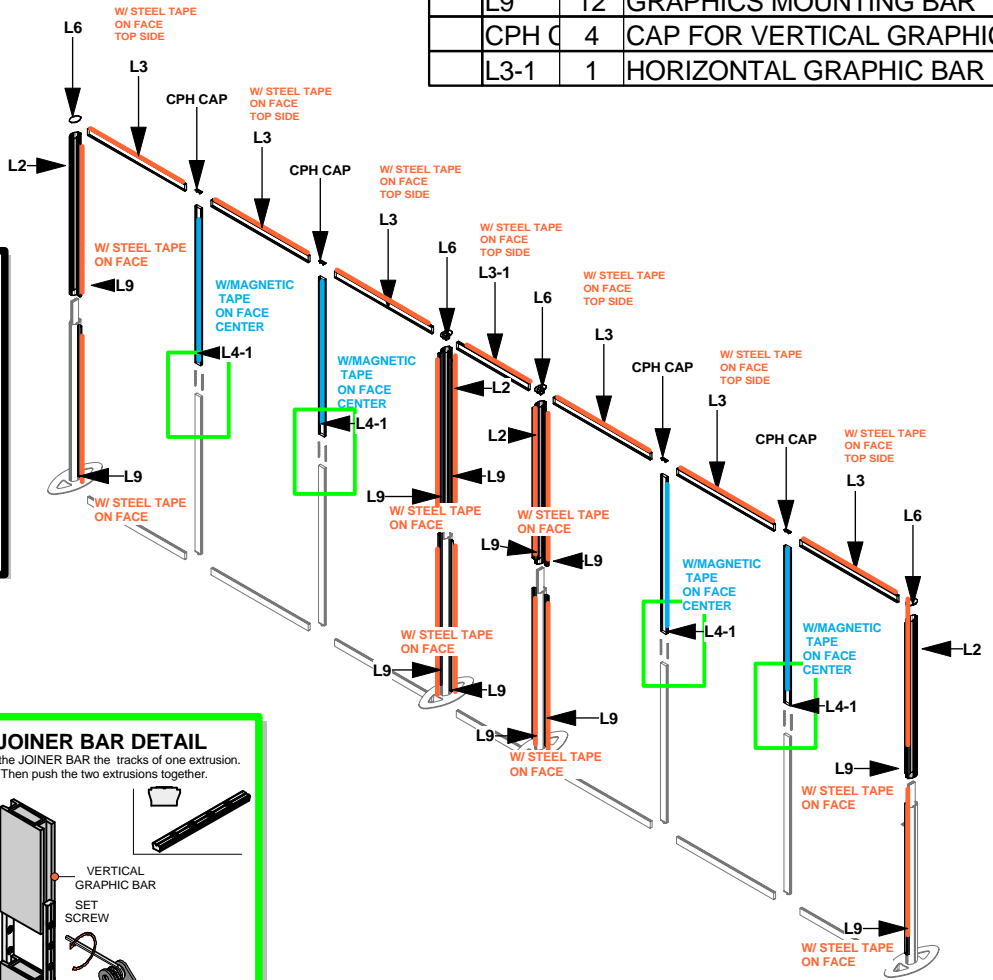
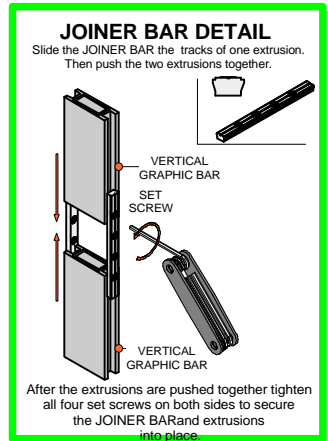
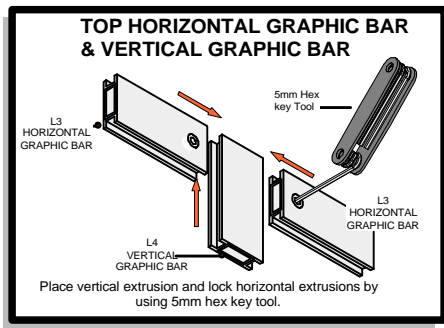
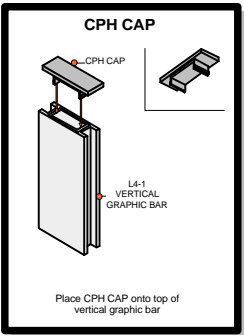
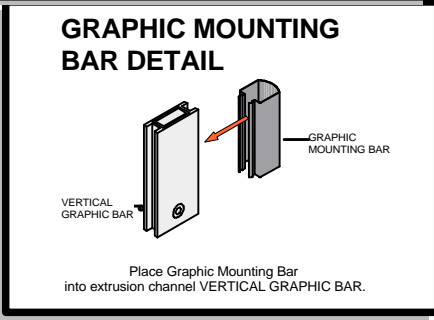
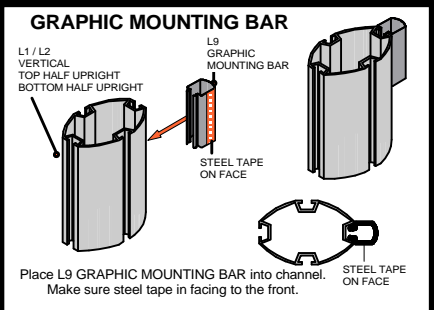

LINEAR

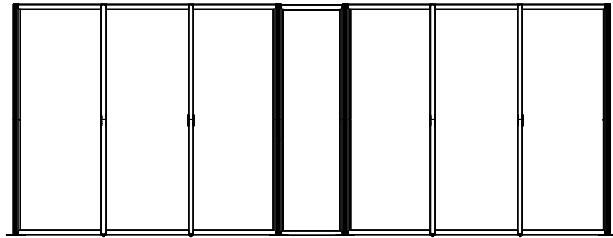

| Code  | # | Description |
|-------|---|-------------|
| L5-2  | 1 | GRAPHICS    |
| L5-1  | 1 | GRAPHICS    |
| L5-3  | 1 | GRAPHICS    |
| IL5-4 | 1 | GRAPHICS    |
| L5-6  | 1 | GRAPHICS    |
| L5-7  | 1 | GRAPHICS    |
| L5-5  | 1 | GRAPHICS    |

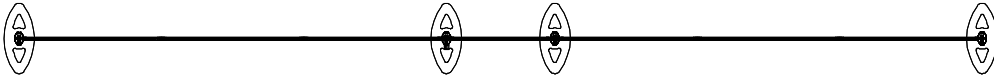

W/ MAGNETIC TAPE  
ON BACKSIDE  
ALL SIDES

L5-1  
W/ MAGNETIC TAPE  
ON BACKSIDE  
ALL SIDES

L5-2  
W/ MAGNETIC TAPE  
ON BACKSIDE  
ALL SIDES

L5-3  
W/ MAGNETIC TAPE  
ON BACKSIDE  
ALL SIDES

IL5-4  
W/ MAGNETIC TAPE  
ON BACKSIDE  
ALL SIDES

L5-5  
W/ MAGNETIC TAPE  
ON BACKSIDE  
ALL SIDES

L5-6  
W/ MAGNETIC TAPE  
ON BACKSIDE  
ALL SIDES

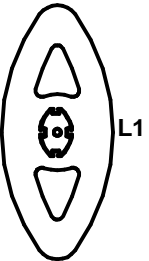

L1



L2



L9

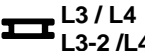

L3 / L4  
L3-2 / L4-1

LINEAR

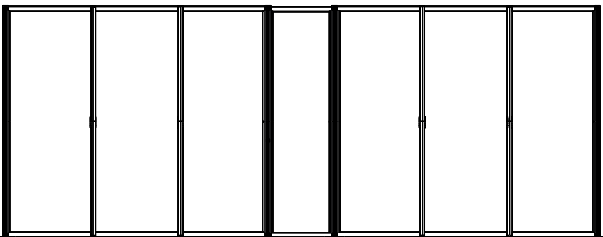
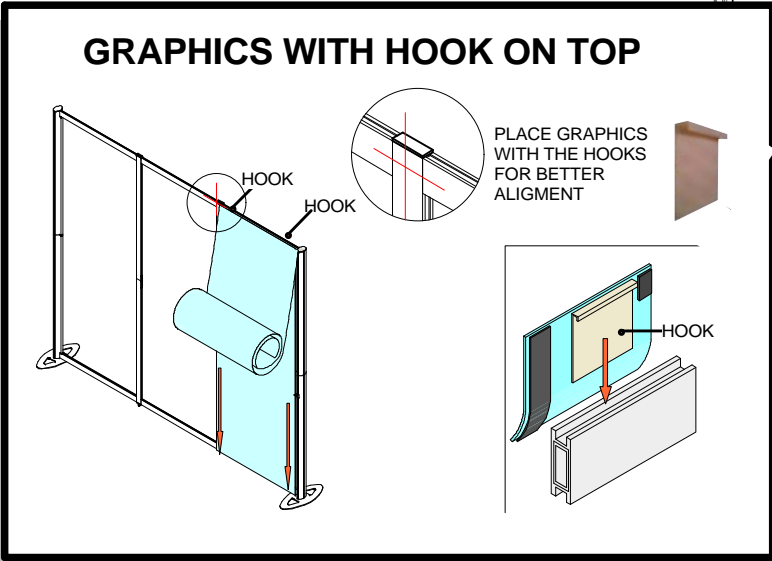

| Code      | # | Description                               |
|-----------|---|---|
| LV3 LIGHT | 4 | GREY SKINNY LIGHT WITH OSRAM TITAN 50W LA |

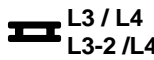
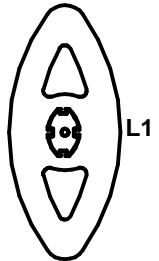
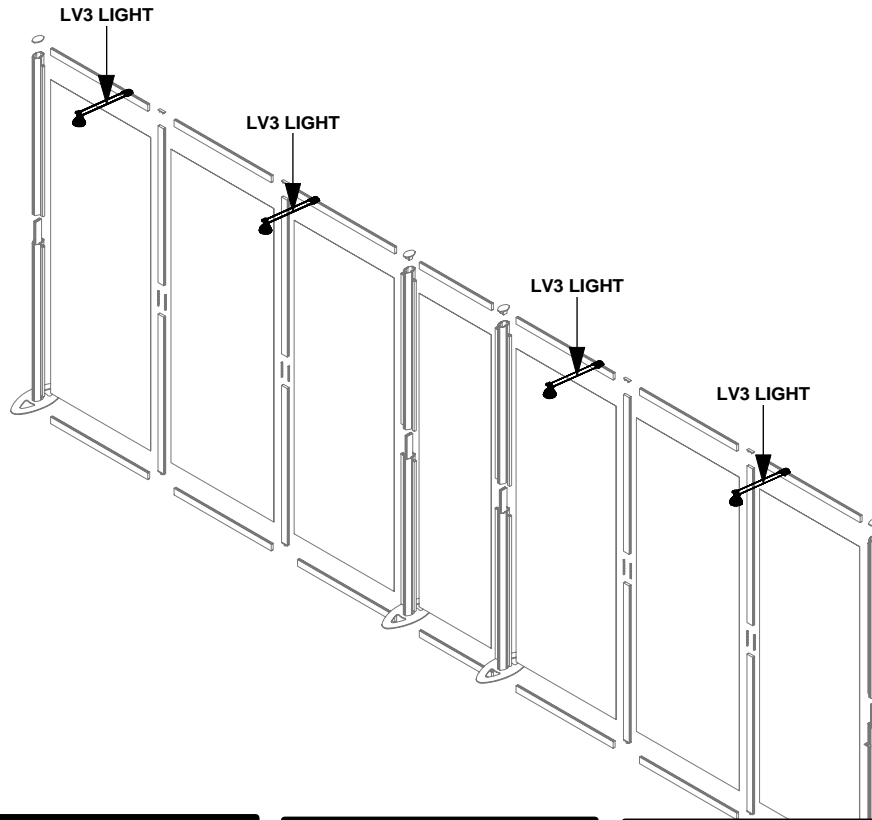
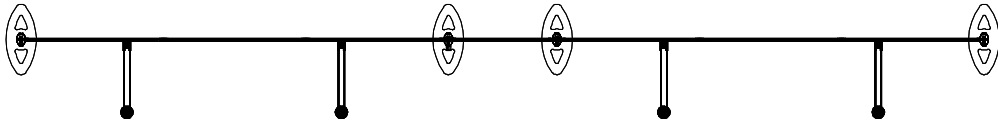

**LINEAR**

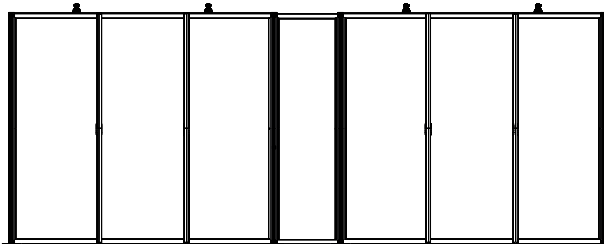
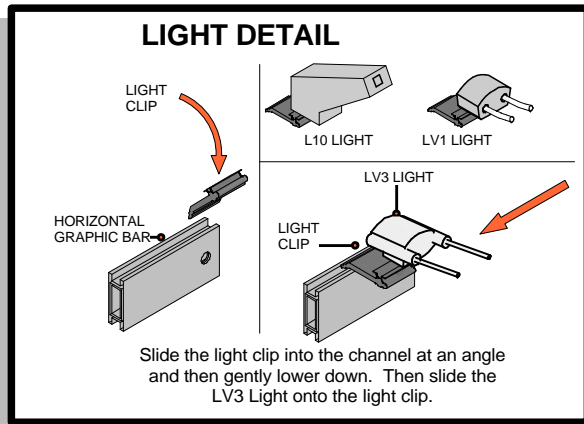

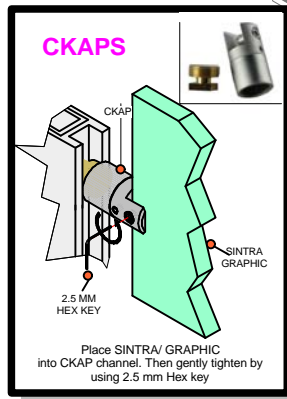
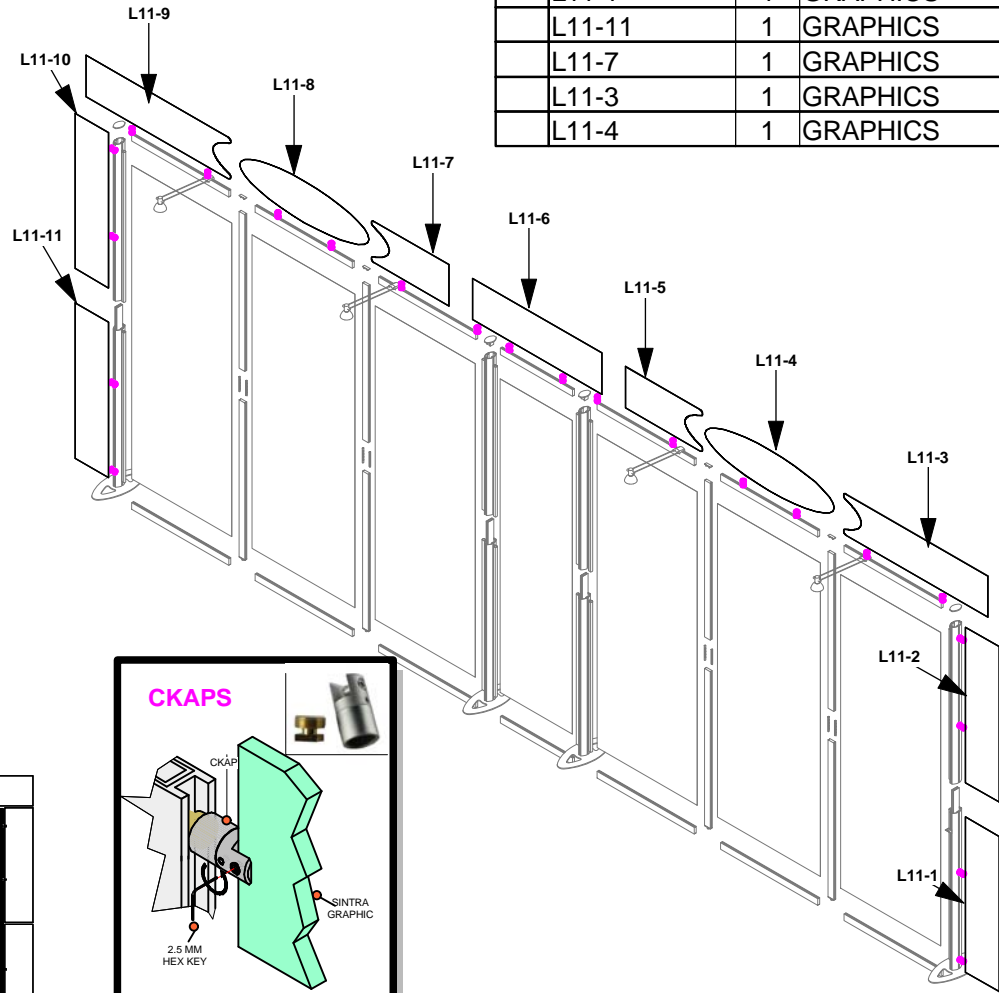
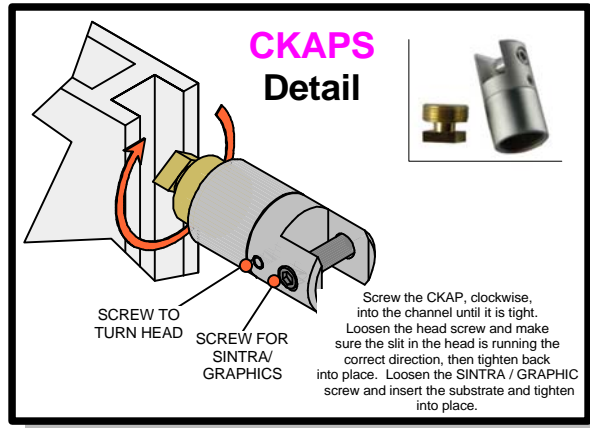
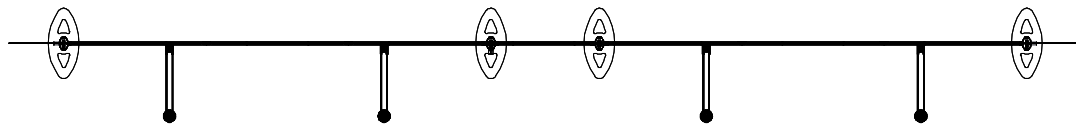

| Code   | #  | Description |
|--------|----|-------------|
| CKAPS  | 22 | STANDOFFS   |
| L11-10 | 1  | GRAPHICS    |
| L11-5  | 1  | GRAPHICS    |
| L11-8  | 1  | GRAPHICS    |
| L11-2  | 1  | GRAPHICS    |
| L11-9  | 1  | GRAPHICS    |
| L11-6  | 1  | GRAPHICS    |
| L11-1  | 1  | GRAPHICS    |
| L11-11 | 1  | GRAPHICS    |
| L11-7  | 1  | GRAPHICS    |
| L11-3  | 1  | GRAPHICS    |
| L11-4  | 1  | GRAPHICS    |

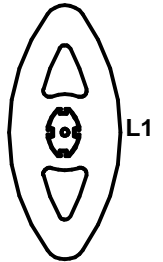

L1



L2



L9

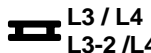

L3 / L4

L3-2 / L4-1

**LINEAR**

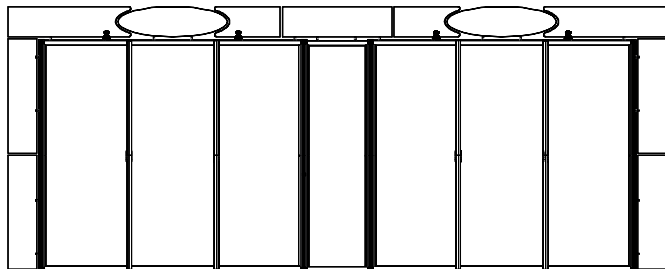

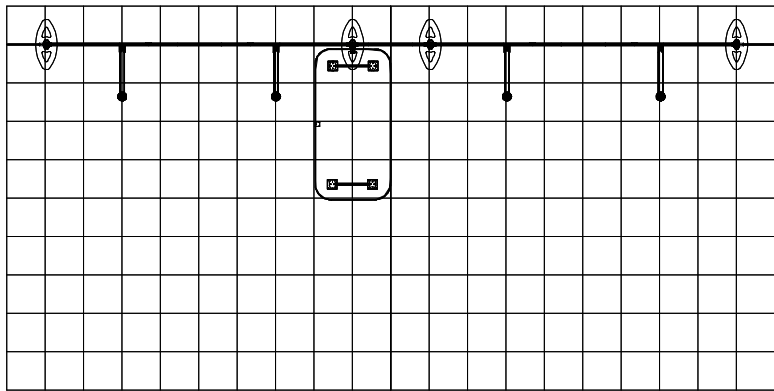

| Code | # | Description   |
|------|---|---------------|
| L18  | 1 | TABLE TOP     |
| L7   | 4 | TABLE LEG     |
| L8   | 2 | TABLE SUPPORT |

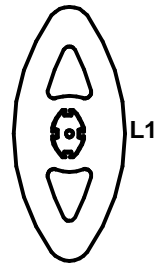

L1

L2

L9

L3 / L4

L3-2 / L4-1

LINEAR

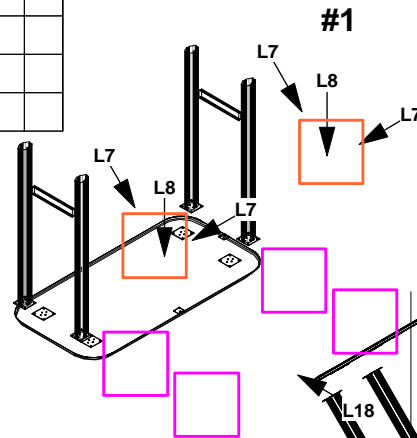
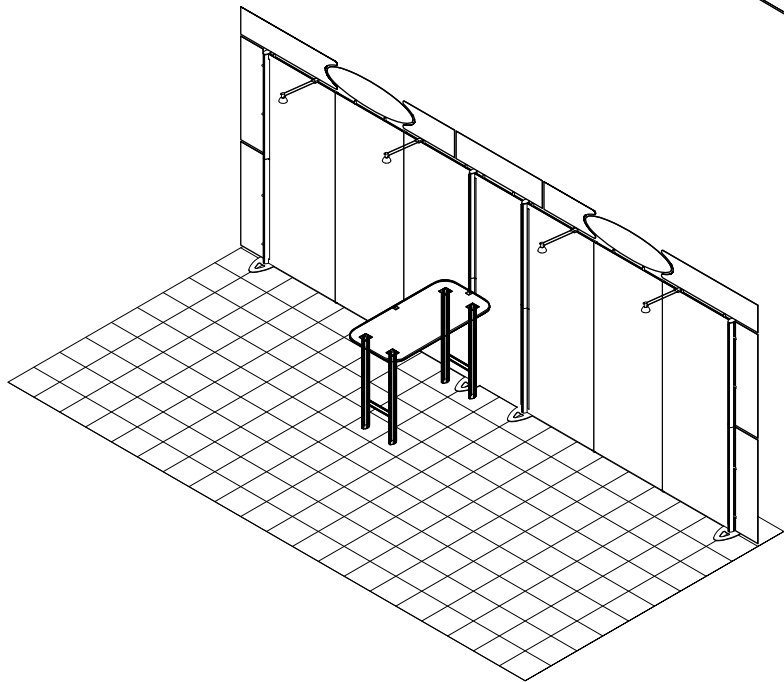

#1

#2

#3

