

ORIGAMI SEG TRUSS INLINE A

PRODUCT CATEGORY: ORIGAMI TRUSS

PRODUCT CODE: ORIGAMI2010-A



On Frame

OnGraphic

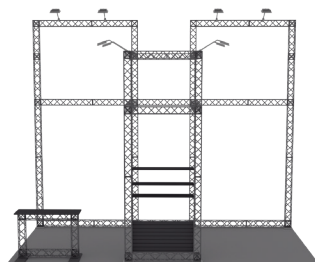
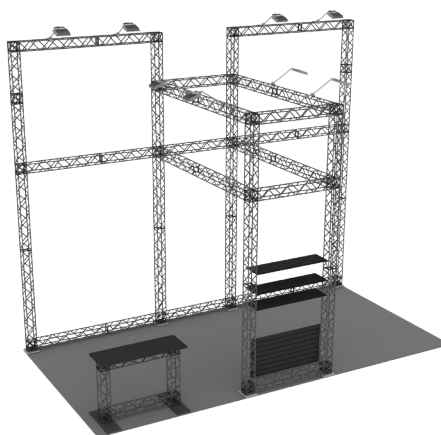

TRUSS FOLDED



TRUSS CUBE CONNECTOR



TRUSS FLAT CONNECTOR



SILICONE EDGE GRAPHICS

PRODUCT DESCRIPTION

Introducing the Origami Truss System – where innovation meets elegance. This cutting-edge 6in x 6in folding truss redefines the dynamics of display systems, offering a portable and sophisticated solution that outshines traditional truss systems in every aspect.

Key Features:

1. Portable Origami Design:

Unleash the power of portability with our Origami Truss System. Unlike conventional truss systems, this folding design ensures easy transportation and quick assembly without compromising on structural integrity.

2. Stunning Silicone Edge Graphics (SEG):

Elevate your brand presence with vibrant and flawless Silicone Edge Graphics (SEG). Choose between single or double-sided displays that can be seamlessly integrated between the truss frame or fully wrapped around, ensuring your message captivates from all angles.

3. Tailored Configurations:

Empower your brand with flexibility. Select from our library of standard configurations for a swift setup or let your creativity shine by designing a custom configuration that aligns perfectly with your unique brand identity and display requirements.

4. Comprehensive Accessories:

Illuminate your brand with a range of accessories crafted for both functionality and visual allure. Enhance your presentation with monitor mounts for interactive experiences, LED lights strategically positioned for front-lit graphics, shelving for product displays, slat walls for additional customization, and counters that invite engagement.

The Origami Truss System is more than a display solution; it's a canvas for your brand story. Whether you're an industry veteran or a newcomer, make a lasting impression with a truss system that seamlessly blends innovation, portability, and customization. Elevate your brand presence with Origami – because your brand deserves a display as unique as its story.

DISPLAY DIMENSIONS	240.8"W x 190.4"H x 121.5"D
GRAPHIC SIZES	See Template Guide

GRAPHIC MATERIAL

Dye Sublimated Black & White Fabric

GRAPHIC FINISHING

12mm x 3mm silicone beading is sewn around the perimeter of the fabric graphic. Silicone beading is hidden from view once installed.

DISPLAY CONSTRUCTION

Iron truss construction with durable black plastic coating

SHIPPING WEIGHTS & DIMENSIONS

ORIGAMI SEG TRUSS INLINE A

PRODUCT CATEGORY: ORIGAMI TRUSS

PRODUCT CODE: ORIGAMI2010-A



On Frame

OnGraphic

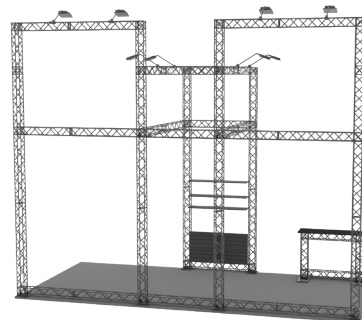
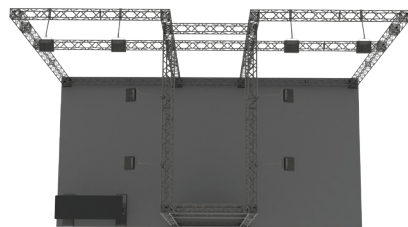
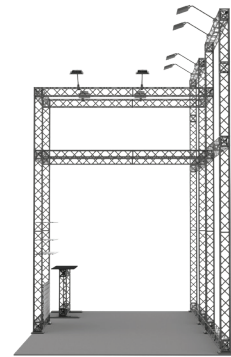
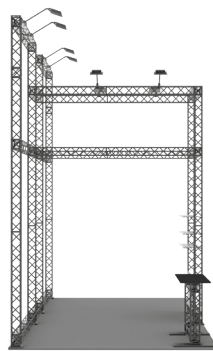
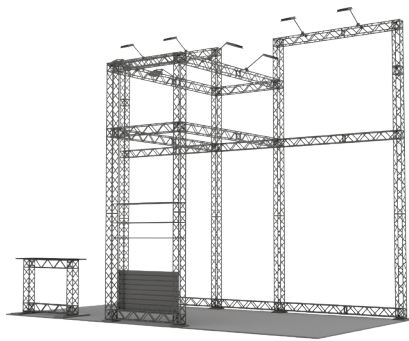

ORIGAMI SEG TRUSS INLINE A

PRODUCT CATEGORY: ORIGAMI TRUSS
PRODUCT CODE: ORIGAMI2010-A



On Frame

OnGraphic

SHIPPING DIMENSIONS

L"	W"	H"	LBS	BOX QTY
37.44	12.87	13.26	36.96	2
49.14	12.87	13.26	47.3	2
60.84	12.87	13.26	56.76	3
6.63	6.63	6.63	2.86	2
25.74	12.87	13.26	42.02	1
33.15	17.16	15.21	52.8	1
37.44	13.26	7.8	5.94	2
TOTALS			451.22	13

ORIGAMI SEG TRUSS INLINE A

PRODUCT CATEGORY: ORIGAMI TRUSS

PRODUCT CODE: ORIGAMI2010-A



On Frame

OnGraphic

PARTS LIST

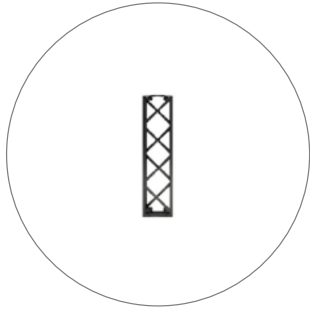

(qty 2) Truss 60cm Length
TRUSS-60CM

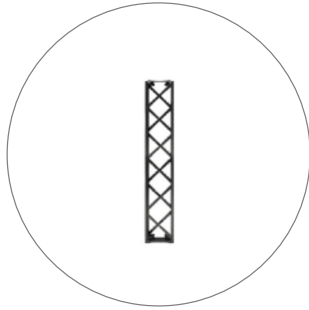

(qty 14) Truss 90cm Length
TRUSS-90CM

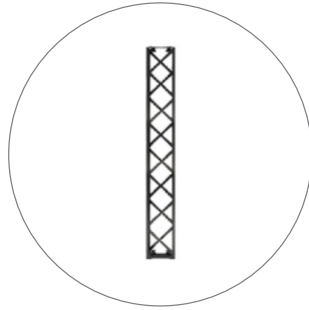

(qty 22) Truss 120cm Length
TRUSS-120CM

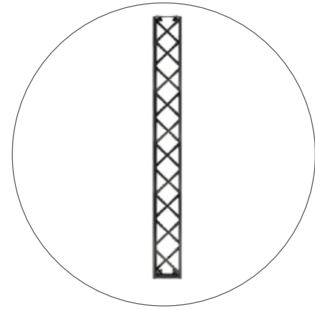

(qty 10) Truss 150cm Length
TRUSS-150CM



(qty 16) Truss Cube Connector
TRUSS-CUBE



(qty 16) Truss Flat Connector
TRUSS-FLAT



(qty 75) Truss SEG Channel
TRUSS-SEG-S



(qty 6) Truss Foot Small
TRUSS-FT-S



(qty 2) Truss Foot Large
TRUSS-FT-L



(qty 4) Truss Slatwall
TRUSS-SLAT



(qty 8) Truss LED Light
w/Bracket
TRUSS-LIGHT



(qty 1) Drill Kit (2 Drills + Bag)
TRUSS-DRILL

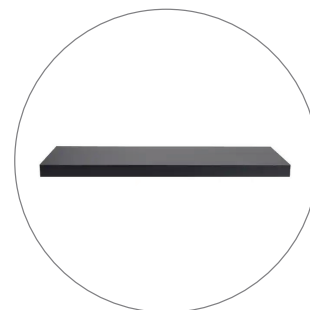

(qty 1) MDF Counter Top
TRUSS-MDF

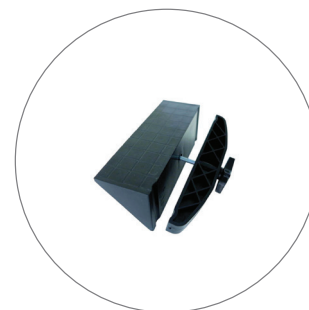

(qty 2) Truss MDF Connector
TRUSS-MDF-CON

ORIGAMI SEG TRUSS INLINE A

PRODUCT CATEGORY: ORIGAMI TRUSS

PRODUCT CODE: ORIGAMI2010-A



On Frame

OnGraphic

TEMPLATE & GRAPHIC INSTALL GUIDE



1. TOP HEADER FRONT
2. FRONT SUPPORT FRAME (BACKSIDE HAS SHELVES)
3. TOP HEADER LEFT
4. TOP HEADER RIGHT
5. HAS FRONT & BACK GRAPHIC - BOTH TEMPLATES HAVE DIFFERENT SIZING
6. HAS FRONT & BACK GRAPHIC - BOTH TEMPLATES HAVE DIFFERENT SIZING
7. TOP HEADER BACK (FACES BACKWARD)

NUMBERS ON THE IMAGE ABOVE INDICATE THE TEMPLATE LOCATION # ON FRAME
PLEASE ADD TEMPLATE LOCATION # TO END OF FILENAME. EX: "ORIGAMI2010-A-1"

ORIGAMI SEG TRUSS INLINE A

PRODUCT CATEGORY: ORIGAMI TRUSS

PRODUCT CODE: ORIGAMI2010-A



On Frame

OnGraphic



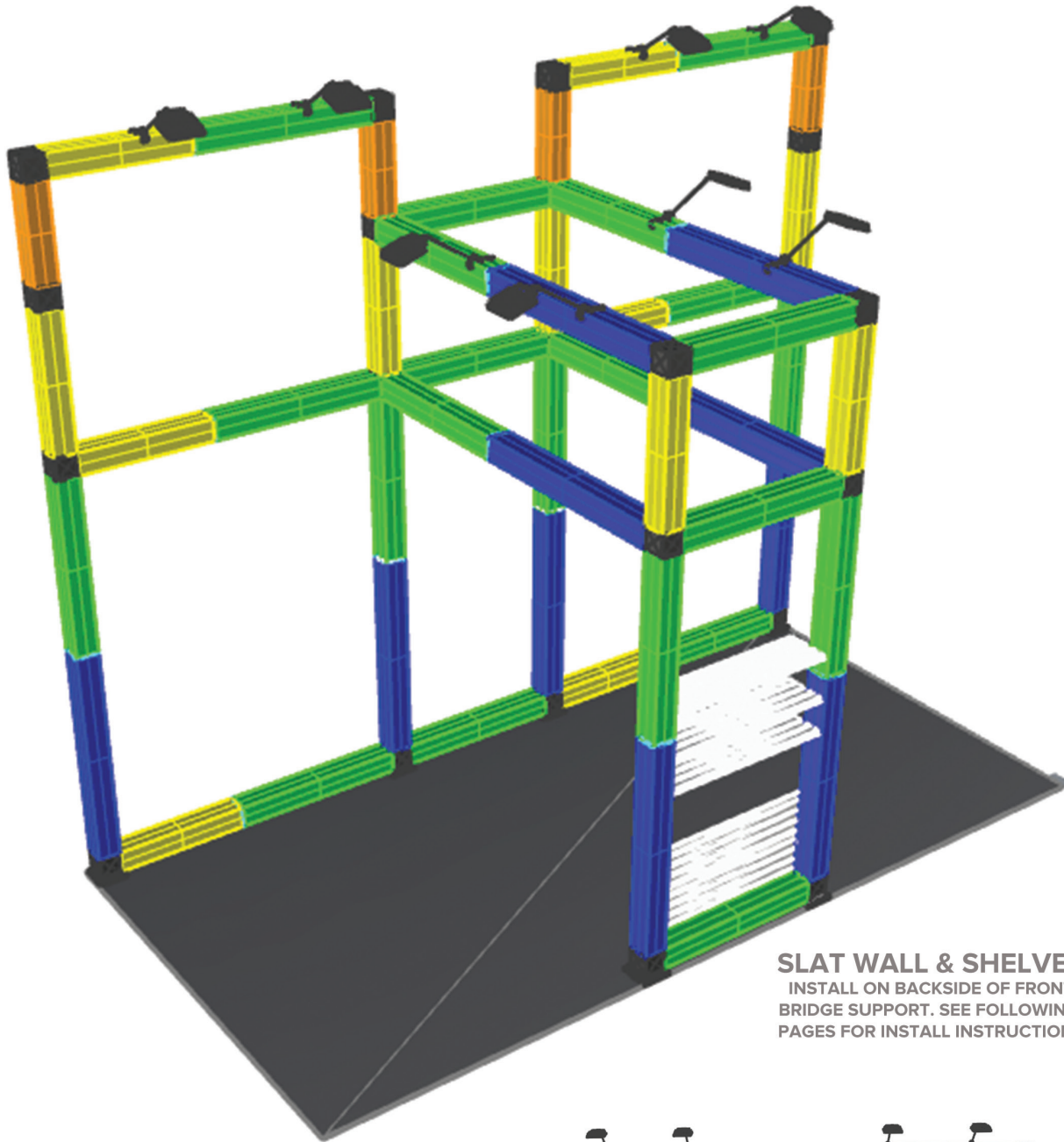





SET UP INSTRUCTIONS



SLAT WALL & SHELVES

INSTALL ON BACKSIDE OF FRONT BRIDGE SUPPORT. SEE FOLLOWING PAGES FOR INSTALL INSTRUCTIONS

TRUSS LENGTH COLOR KEY

		TRUSS-60CM
		TRUSS-90CM
		TRUSS-120CM
		TRUSS-150CM

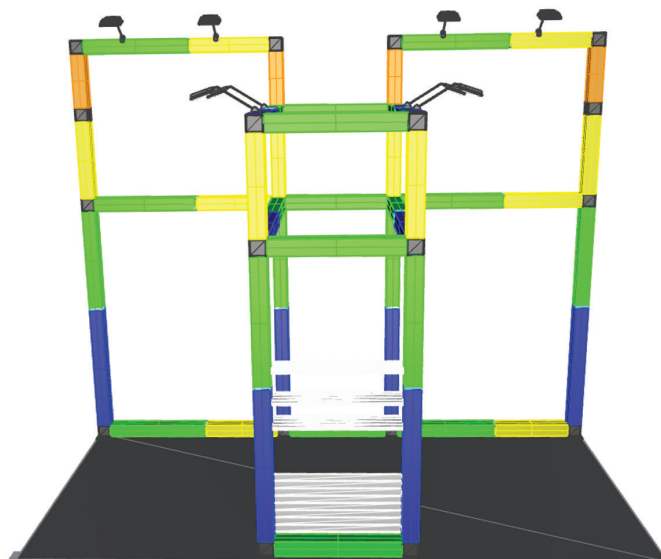

SET UP INSTRUCTIONS CUBE CONNECTOR

TRUSS-CUBE

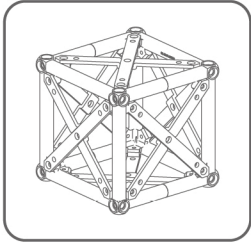

TRUSS

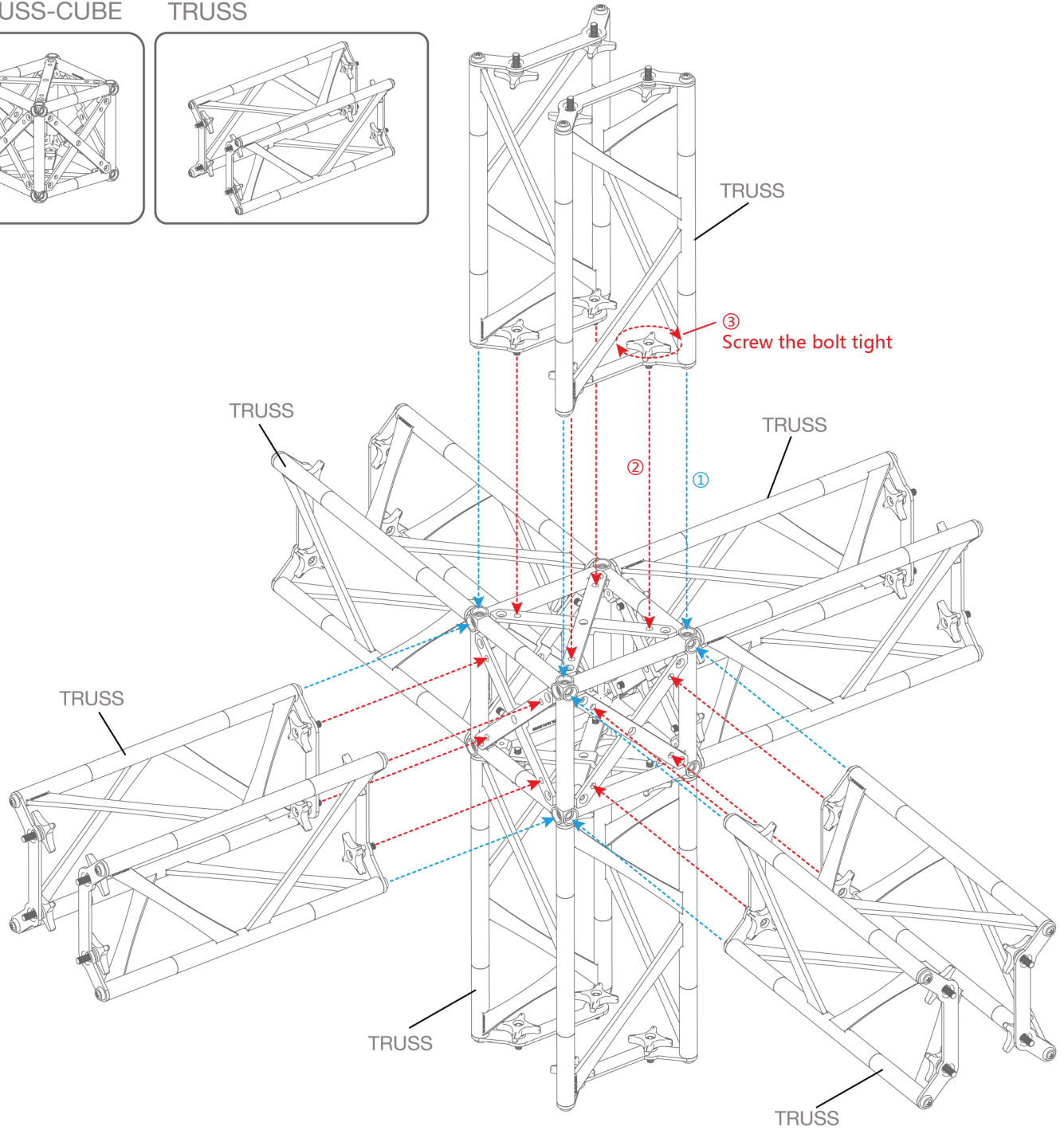
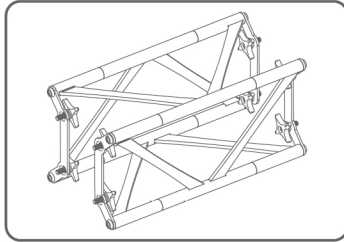



On Frame

OnGraphic

SET UP INSTRUCTIONS FLAT CONNECTOR

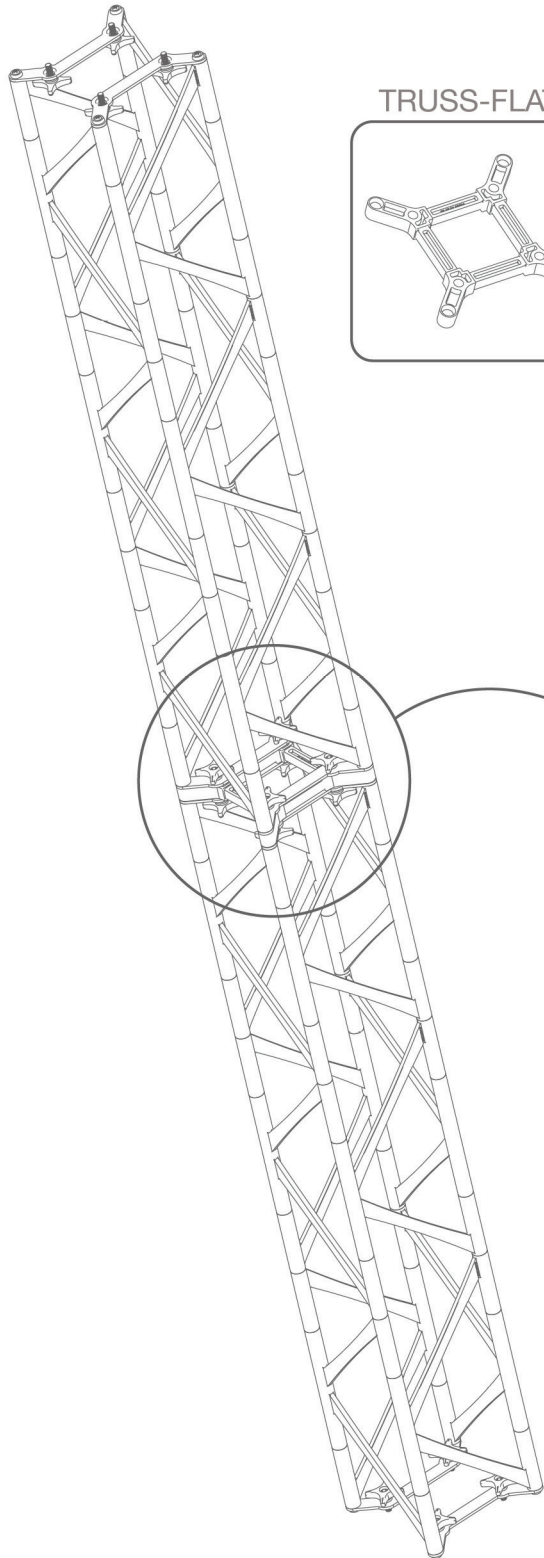

TRUSS-FLAT

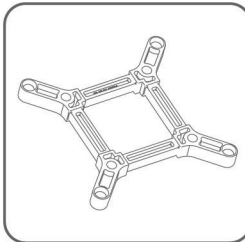

TRUSS

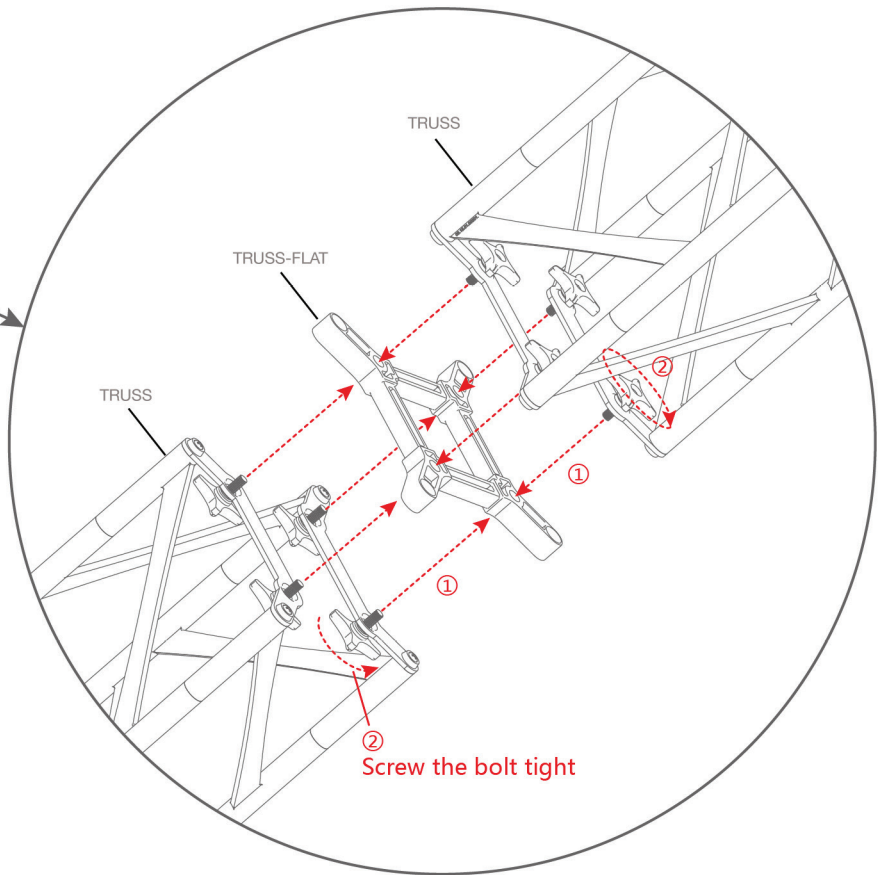
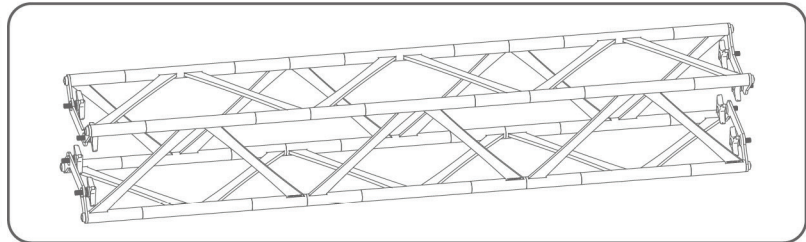

SET UP INSTRUCTIONS SEG CHANNELS

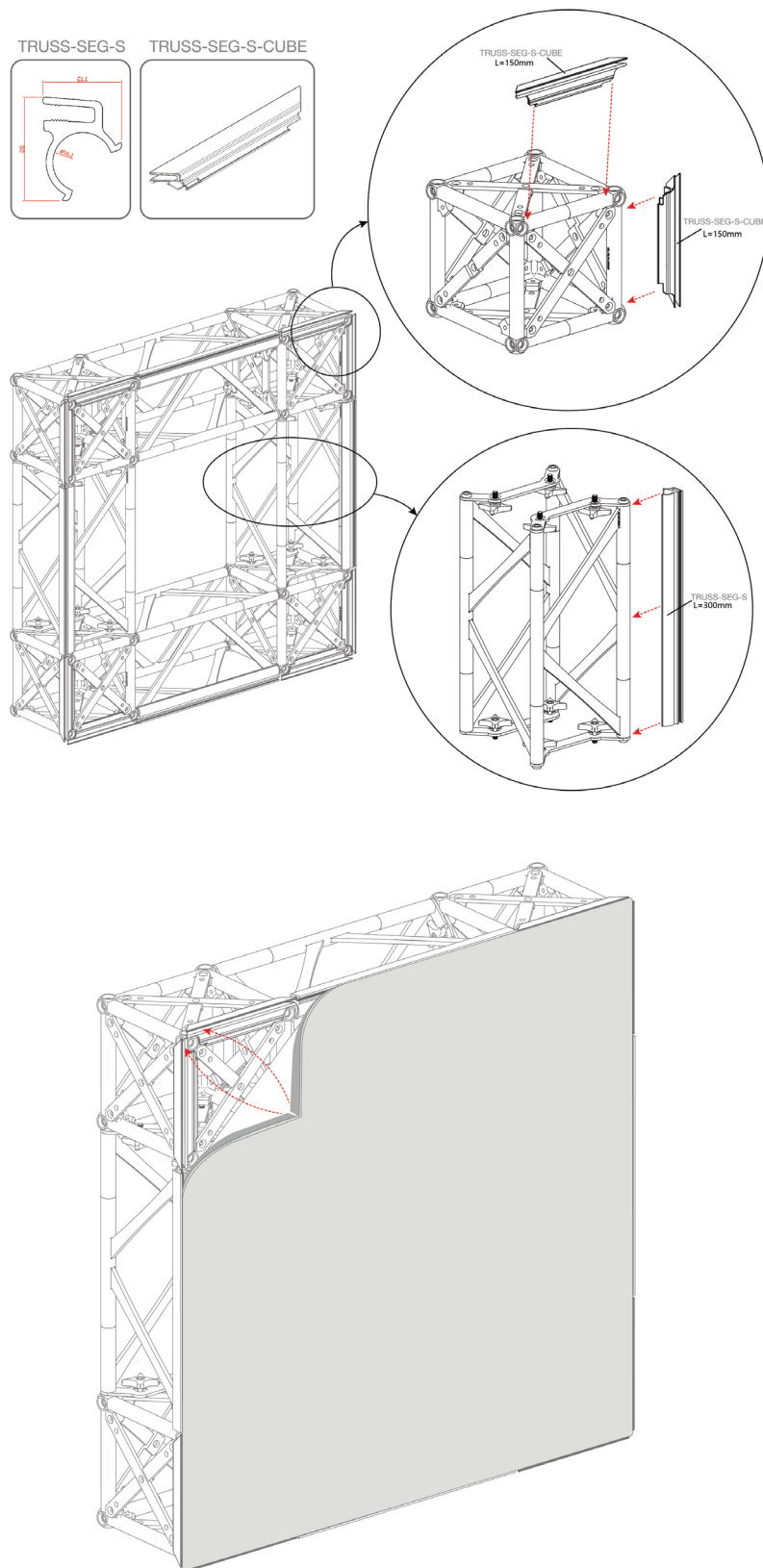

SET UP INSTRUCTIONS SLAT WALL & SHELVES

TRUSS-SLAT

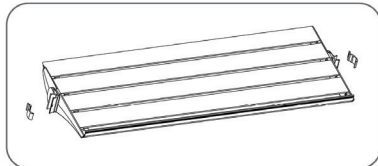

Step 1

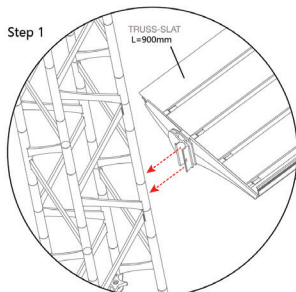

Step 2

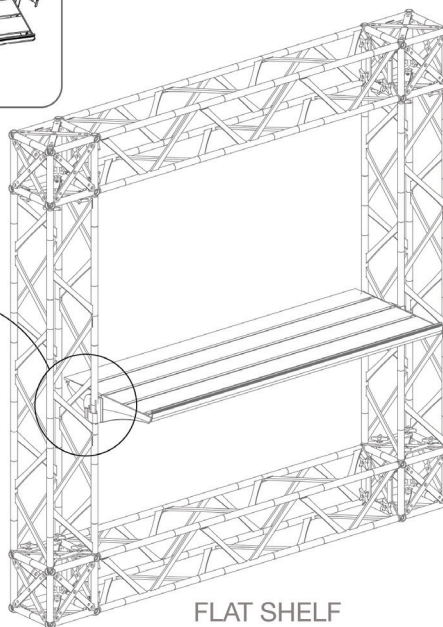
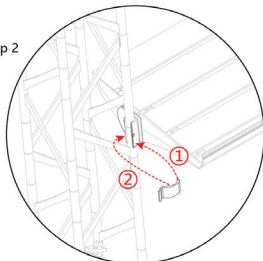

FLAT SHELF

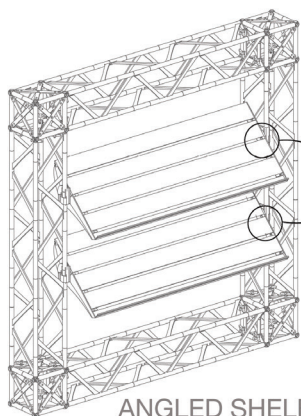

ANGLED SHELF

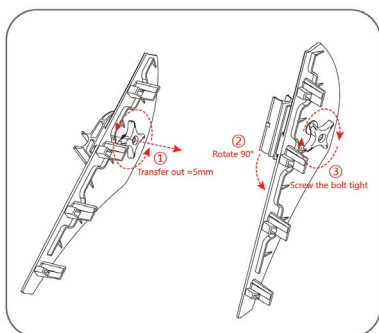
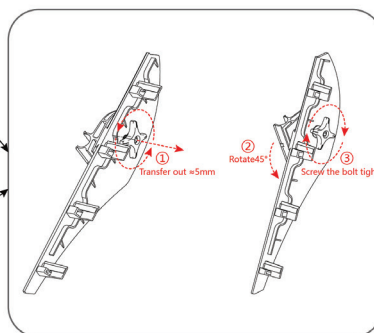

SLATWALL