

BERTY SNAP FRAME (SMALL)



Product Features

- Sturdy aluminum construction
- Holds one piece of 8.75"W x 12"H paper
- Viewable area of 8 1/4" x 11 3/4"
- Angle can be adjusted from vertical to horizontal
- Height adjustable from 34" to 48" with 19 separate height adjustments
- Base 10" diameter

Stand Total Height	34" to 48"
--------------------	------------

Base Width	10"
------------	-----

Construction

Aluminum snapframe with steel base and telescopic pole

Weights - Dimensions

Shipping Weight	8 lbs
-----------------	-------

Shipping Dimensions	34"x 11.5"x 3.5"
---------------------	------------------

Parts List

(1) Frame w/ Telescopic Pole	(1) Matte Plastic Overlay
------------------------------	---------------------------

(1) Base	
----------	--

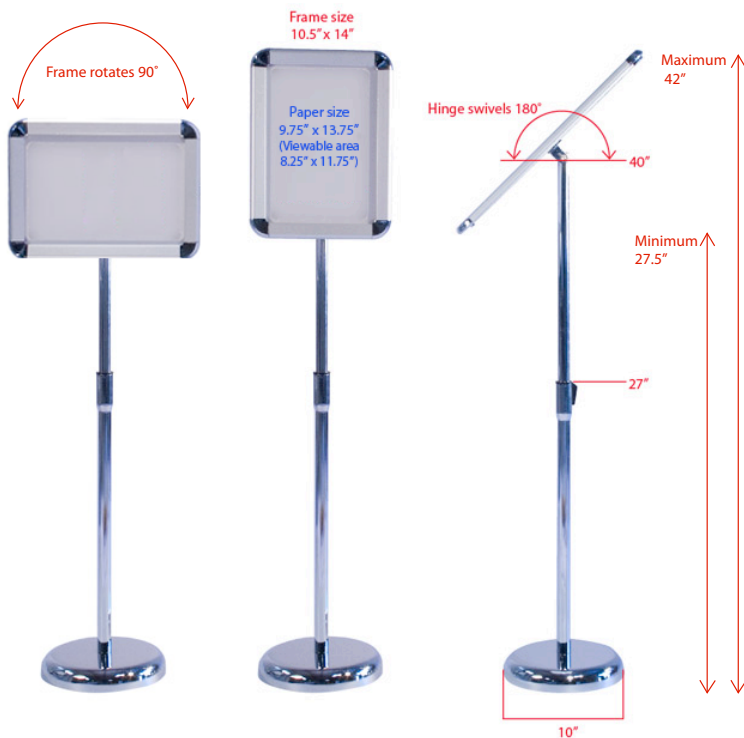

BERTY SNAP FRAME (LARGE)



Product Features

- Sturdy aluminum construction
- Holds one piece of 11.75"W x 16.5"H paper
- Angle can be adjusted from vertical to horizontal
- Height adjustable from 36" to 51" with 19 separate height adjustments
- Base 10" diameter

Stand Total Height	27" to 48"
--------------------	------------

Base Width	10"
------------	-----

Construction

Aluminum snapframe with steel base and telescopic pole

Weights - Dimensions

Shipping Weight	9 lbs
-----------------	-------

Shipping Dimensions	34"x 19"x 3.5"
---------------------	----------------

Parts List

(1) Frame w/ Telescopic Pole	(1) Matte Plastic Overlay
------------------------------	---------------------------

(1) Base	
----------	--

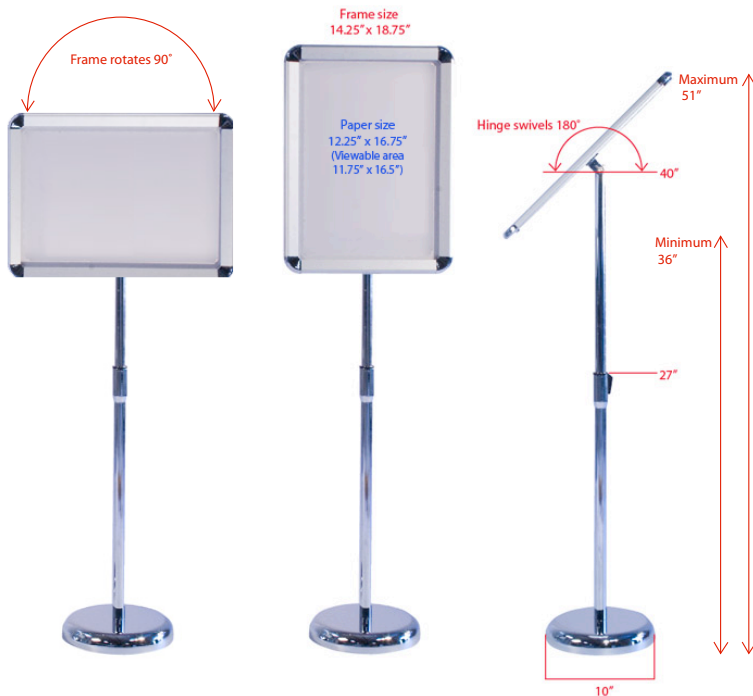

INDOOR SIGN DISPLAY 1

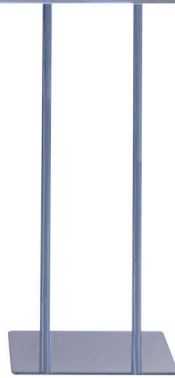
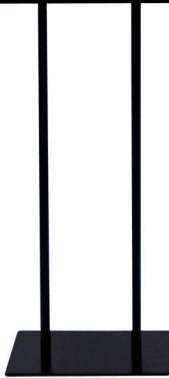

Available in black and chrome



Product Features

- Holds a 22"W x 28"H sign on 0.25" form board
- Height 60"

Stand Total Height	60"
Base Size	10"W x 14"D
Frame	22.5"W x 28.25"H
Viewable Area	20.75"W x 26.75"H
Frame Border	0.75" thick
Top Loading Slot	0.25"

Construction

Aluminum frame with steel base

Weights - Dimensions

Shipping Weight	17 lbs
Shipping Dimensions	30" x 23" x 1.5"

Parts List

(1) Frame	(1) Allen Wrench
(2) Legs	(1) Base
(2) Screws	



INDOOR SIGN DISPLAY 2 HEAVY BASE



Available in black and chrome



Product Features

- Holds a 22"x28" sign on 0.25" form board
- Height 60"
- Viewable Area : 21"W x 26.75"H

Stand Total Height	60"
--------------------	-----

Base Size	23.5"W x 14"D
-----------	---------------

Construction

Aluminum frame with steel base

Weights - Dimensions

Shipping Weight	16 lbs
-----------------	--------

Shipping Dimensions	46" x 23" x 2"
---------------------	----------------

Parts List

(1) Frame	(2) Allen Wrench
-----------	------------------

(2) Legs	(1) Base
----------	----------

(2) Long Screws	(4) Small Screws
-----------------	------------------

Graphic Specification

Frame: 22.25" x 28.25"

Viewable Area : 21" x 26.75"

Frame Border: 0.75" thick

Top Loading Slot: 0.25"

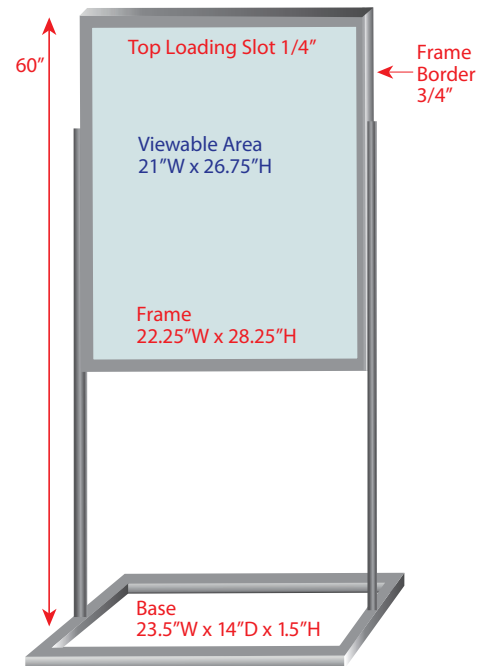

PRODUCT CODE
RSF

ROLLING SNAP FRAME DISPLAY SINGLE-SIDED



Product Features

- Sturdy aluminum construction
- Holds one piece of paper vertical 22.8" x 33" (viewable 22" x 32.375")
- Indoor/Outdoor
- Single-sided
- Includes protective non glare overlay

Note: For outdoor use, paper must be UV protected and waterproof.

Stand Height	64.5"
Stand Width	30"
Stand Depth	22.75"

Construction

Aluminum snap frame with aluminum feet and plastic casters

Weights - Dimensions

Shipping Weight	26 lbs
Shipping Dimensions	3.5" x 3.5" x 62.5"

Parts List

(1) Frame	(4) Screws
(2) Feet w/ Castors	(1) Plastic cover sheet

Graphic Specification

Graphic Size: 23.625"W x 33.5"H (viewable 23" x 32.875")



SF-3 SIGN FRAME



Product Features

- 0.25" top entry slot
- Frame is open 2 sides
- Size 9" X 11"
- Pole adjusts from 26" to 49"
- Weight 10 lbs. Black
- Holds material printed on 1/4"

Stand Total Height	38.5" to 60.5"
Base	12" x 12"

Construction

Aluminum frame and pole with steel base

Weights - Dimensions

Shipping Weight	10 lbs
Shipping Dimensions	40" x 13" x 2.5"

Parts List

(1) Aluminum Frame	(1) Telescopic Aluminum Pole
(1) Steel Base	(2) Screws

Graphic Specification

Frame: 9" x 11.25"

Viewable Area : 7" x 9.5"

Frame Width: 1"

Top Loading Slot: 0.25"



EF-1 SIGN DISPLAY



Product Features

- Curved 8.5" X 11" Floor display with 9" X 14" oval base.
- Print your own signs and drop in behind the provided non-glare overlay
- Base size: 9" X 14"

Stand Total Height	53"
Round Base	14" x 9"

Construction

Aluminum construction with plastic base

Weights - Dimensions

Shipping Weight	11 lbs
Shipping Dimensions	52 1/2" x 11 1/2" x 3"

Parts List

(1) Aluminum display frame	(1) Steel oval base
(1) Curved Aluminum Pole	(1) Plastic overlay
(2) Screws	

Graphic Specification

Frame: 8" x 11"

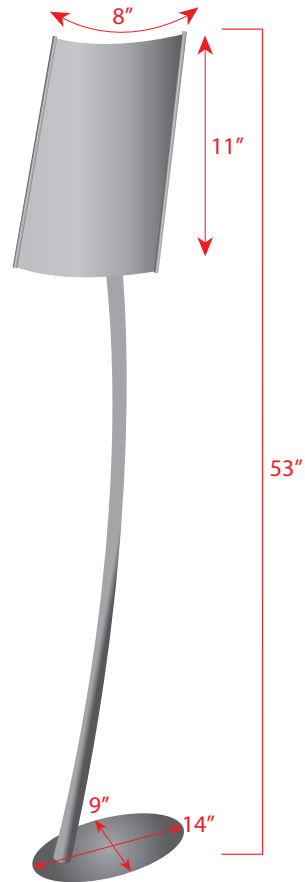

ALUMINUM SNAP FRAME



Product Features

- Easy to load aluminum snap frame.
- Good for indoors and outdoors.
- Comes with two plastic overlays.

Display Height	46"
Display Width	22.875"
Display Depth	32.5"

Construction

Aluminum snap frame

Weights - Dimensions

Shipping Weight	24 lbs
Shipping Dimensions	40" x 28" x 3"

Parts List

(1) Aluminum Snap Frame	(2) Plastic Overlays
-------------------------	----------------------

Graphic Size

23.25" x 33"

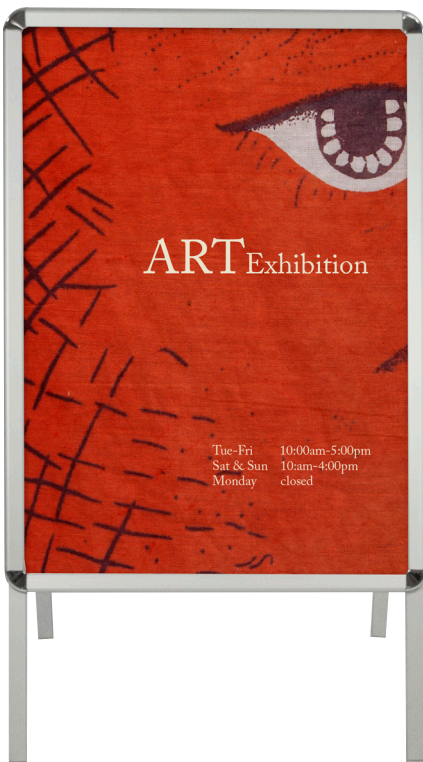

SIGNICADE



Product Features

Changeable sign holds one interchangeable 24" x 36" (2 ft x 3 ft) sign. Ideal for parking lots, sidewalk displays, and more. Holds sign blanks and also accepts vinyl directly onto its face. These durable signs will never rust, splinter, or need painting. Fill stand with water for additional weight.

Height	45 1/2"
--------	---------

Width	24 1/2"
-------	---------

Construction

Plastic construction

Weights - Dimensions

Shipping Weight	20 lbs
-----------------	--------

Shipping Dimensions	28"x 6"x 52"
---------------------	--------------

Parts List

(1) Signicade	(2) Plugs for fill holes
---------------	--------------------------

Graphic Specification

Graphic Size: 24.5" x 36.5"

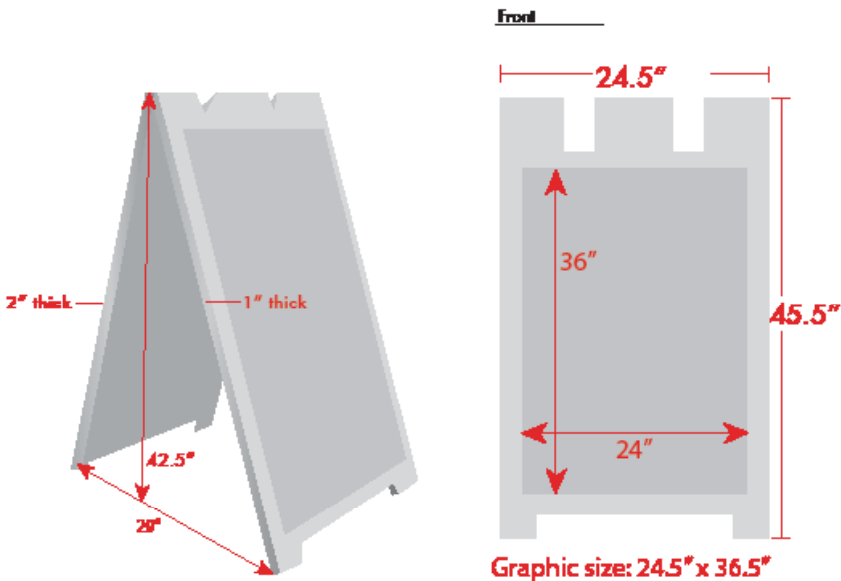

WATER BASE SNAP FRAME

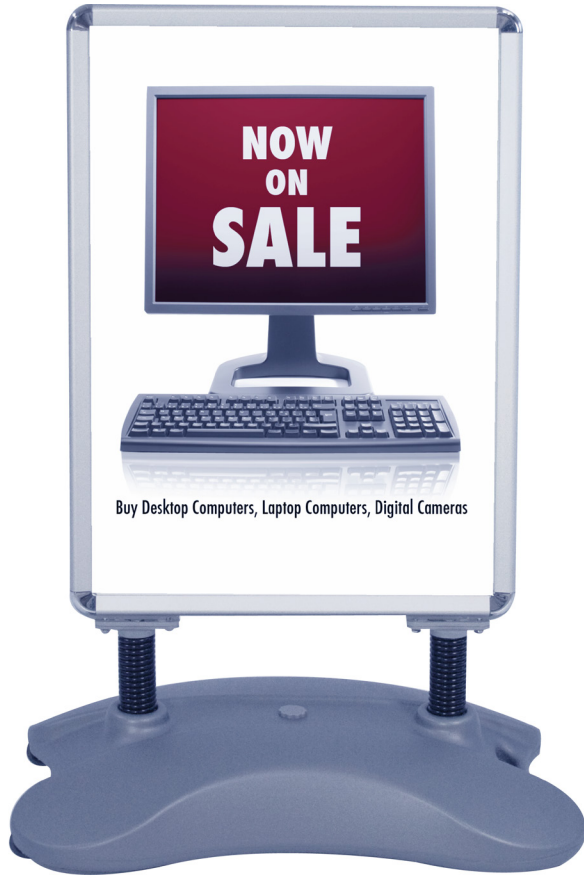

Product Features

Easy open snap frame with waterbase

Overall Dimension	32"W x 46.5"H x 20"D
Base	32"W x 5.5"H x 20"D
Frame	25"W x 34.5"H x 1.5"D
Insert Size	23"W x 32.5"H
Viewing Area	22.5"W x 32.25"H

Construction

Aluminum snap frame w/plastic water fillable base

Weights - Dimensions

Shipping Weight	38 lbs
Shipping Dimensions	9"x 26"x 44"
Weight of stand with water	85 lbs

Parts List

(1) Aluminum snap frame	(1) Water fillable base
(2) Large Washers	(2) Small washers
(2) Screws	

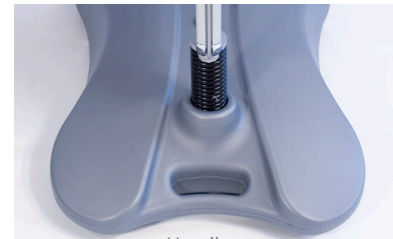

Handle



Wheels