

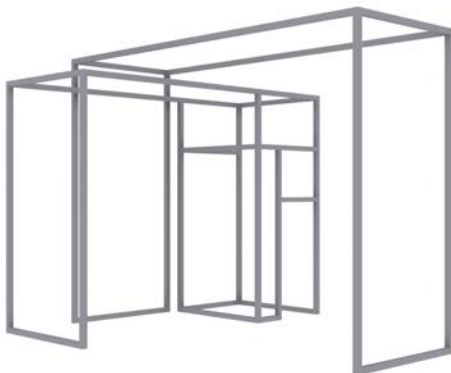

On frame On graphic

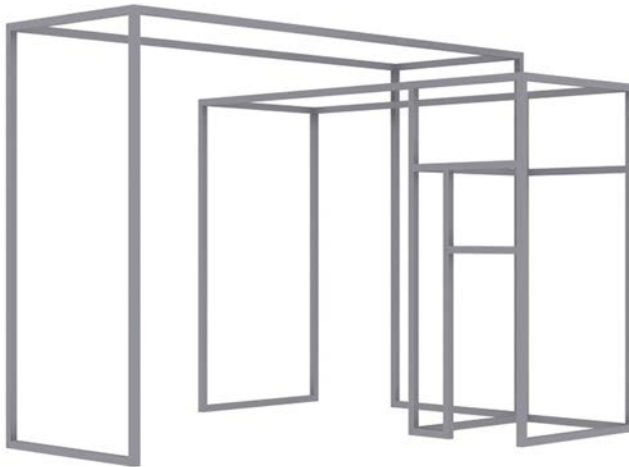

PRODUCT DESCRIPTION

The Cabo aluminum extrusion profile system is an elegant and versatile solution for all of your display needs. Featuring a sleek silver anodized finish, the Cabo is the perfect solution for tradeshow booths, retail environments, pop up shops, or any place aluminum framing is needed. The profiles are available in standard 40mm and 80mm profile widths and in different shapes allowing you to turn your display vision into reality. Promote your company, new products, etc with custom dye sublimated fabric graphics. 12mm x 3mm silicone beading (SEG) is sewn around the perimeter of each fabric panel for easy installation and removal of your graphics. Choose from one of our pre designed configurations or contact us for a quote on something totally custom.

DISPLAY DIMENSIONS	237" W x 172.24" H x 198" D
GRAPHIC SIZE	See Template Page

GRAPHIC MATERIAL

Dye-Sub Black & White Fabric

GRAPHIC FINISHING

12mm x 3mm silicone beading is sewn around the perimeter of the fabric graphic. Silicone beading is hidden from view once installed.

DISPLAY CONSTRUCTION

Extruded aluminum profile frame with aluminum and steel components

SHIPPING WEIGHTS & DIMENSIONS

Shipping Weight (LTL weight includes crate)	1076 lbs (frame only) - LTL ONLY
	1151 lbs (frame & graphic) - LTL ONLY 75 lbs (graphic only) - UPS
Crate Shipping Dimensions	102"L x 49.5"W x 44.5"H (Graphic Package & Hardware Only)

GRAPHIC TURN AROUND TIME

5 business days after proof approval for up to 2 booths

AVAILABILITY	PFC
--------------	-----

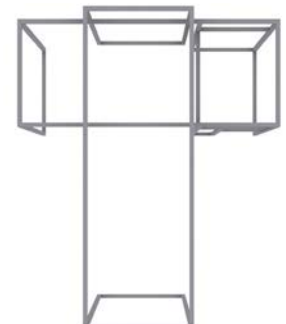
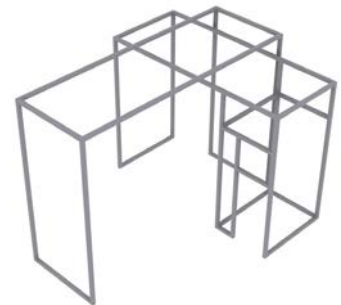

PARTS LIST HARDWARE ONLY

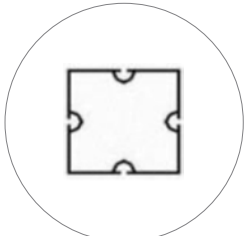

CABO-80 76.4" W
(qty 8)

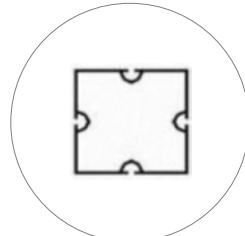

CABO-80 86.1" W
(qty 8)

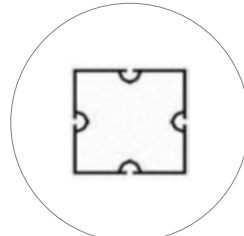

CABO-80 74.8" W
(qty 4)

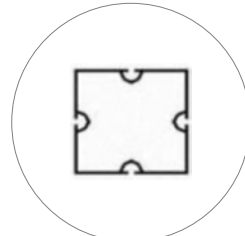

CABO-80 56.9" W
(qty 3)

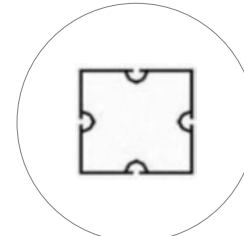

CABO-80 74.8" W
(qty 10)

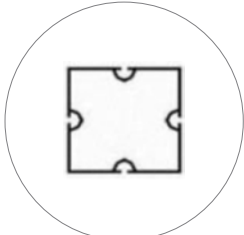

CABO-80 76.9" W
(qty 6)

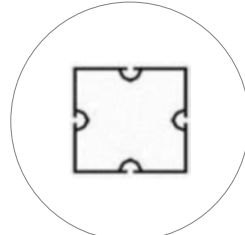

CABO-80 95.85" W
(qty 4)

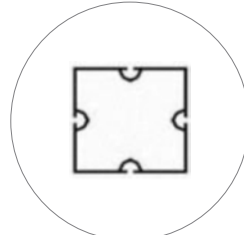

CABO-80 16.3" W
(qty 1)

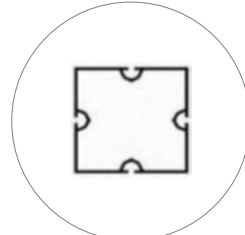

CABO-80 55.3" W
(qty 3)

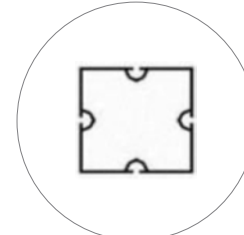

CABO-80 35.8" W
(qty 1)

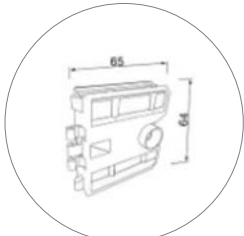

CABO-80-LOCK
(qty 43)

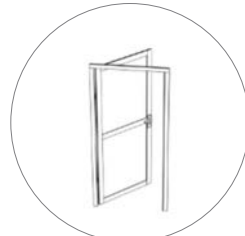

CABO-DOOR
(qty 1)

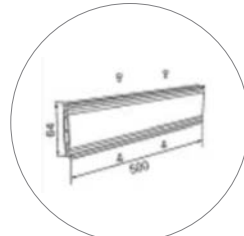

(CABO-80-ADPT)
(qty 16)

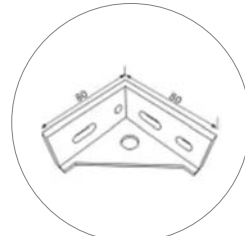

CABO-CS
(qty 4)

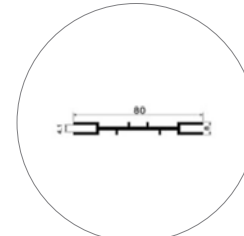

CABO-80-SEG 146.4" W
(qty 4)

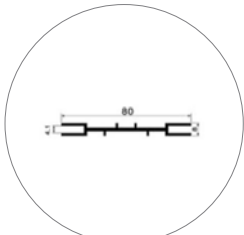

CABO-80-SEG 165.9" W
(qty 4)

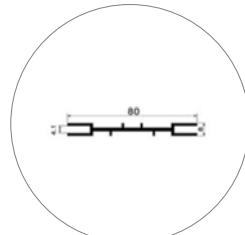

CABO-80-SEG 74.7 W
(qty 8)

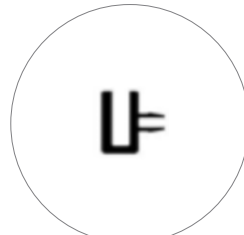

CABO-SEG-PLASTIC 230.6" W
(qty 2)

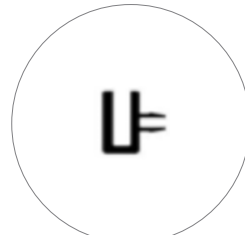

CABO-SEG-PLASTIC 191.7" W
(qty 2)

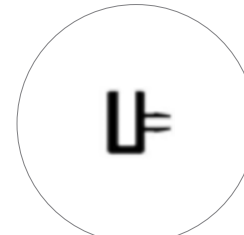

CABO-SEG-PLASTIC 110.6" W
(qty 6)

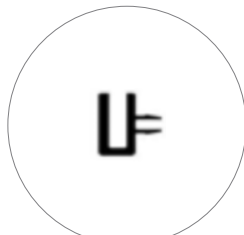

CABO-SEG-PLASTIC 110.6" W
(qty 6)

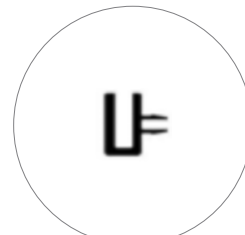

CABO-SEG-PLASTIC 16.3" W
(qty 2)

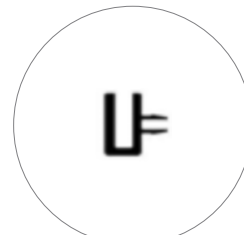

CABO-SEG-PLASTIC 55.2" W
(qty 2)

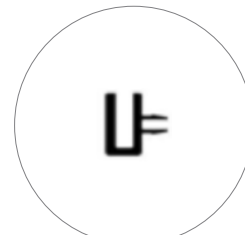

CABO-SEG-PLASTIC 35.7" W
(qty 2)

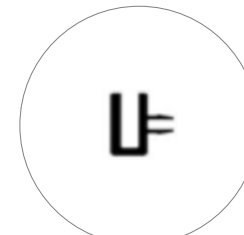

CABO-SEG-PLASTIC 31.8" W
(qty 2)

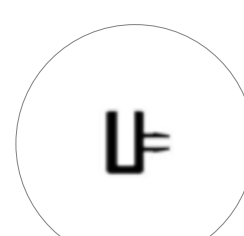

CABO-SEG-PLASTIC 74.7" W
(qty 6)



CABO-HHS
(qty 130)

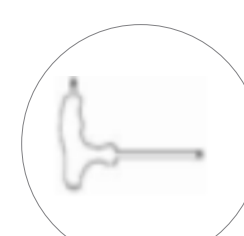

CABO-TTORX
(qty 1)



CABO-LTORX
(qty 1)

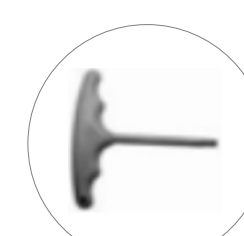

CABO-TSCREWDRIVER
(qty 1)

Template Guide

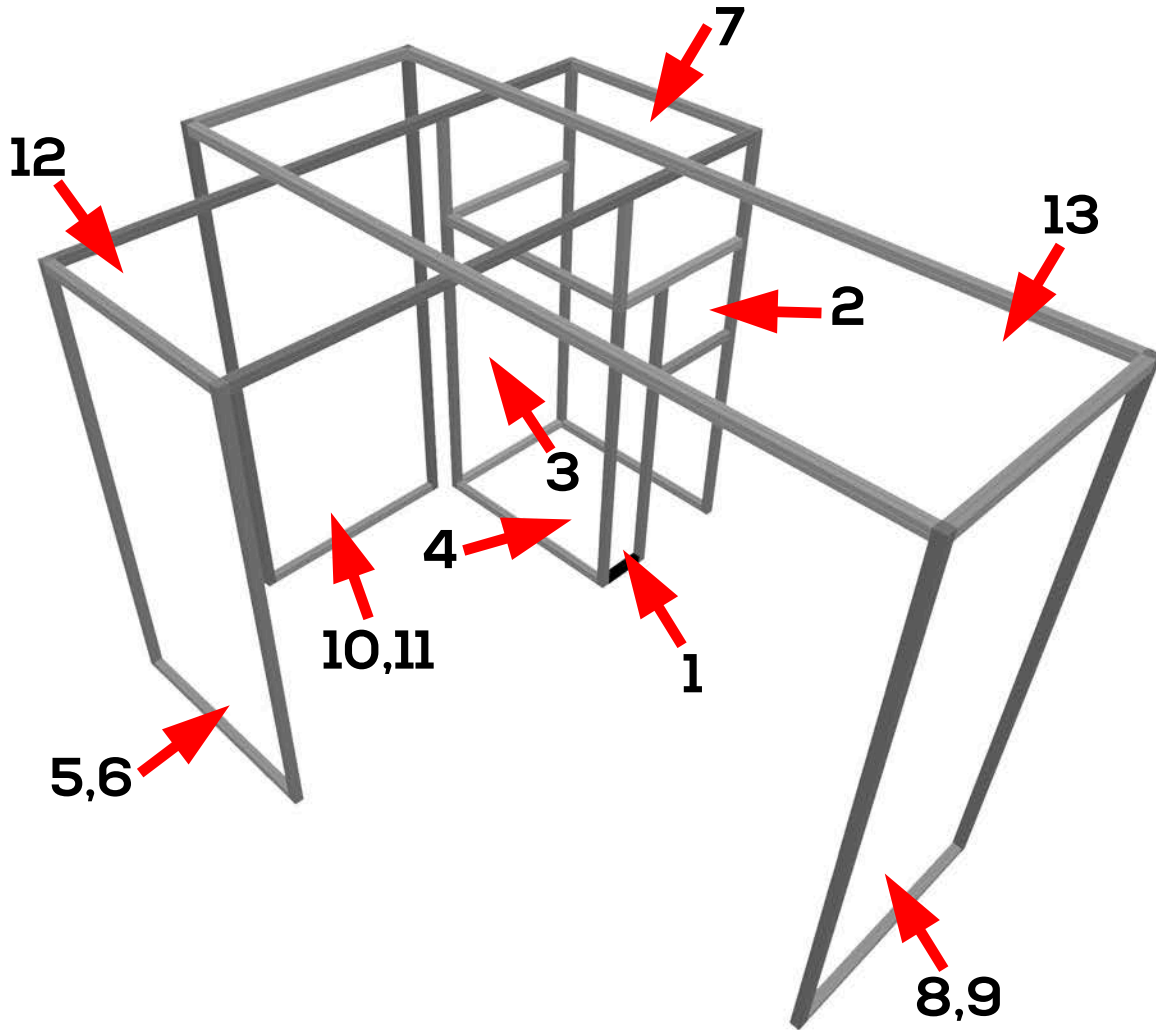

PANEL	DIMS	NOTES
1	16.3" W x 110.6"H	Outside Print
2	35.8" W x 31.9" H	Outside Print Above Door
3	55.3" W x 110.6" H	Outside Print Back Tower
4	74.8" W x 110.6"H	Outside Print Left Side Tower
5	74.8" W x 152.75"H	Outside Print
6	74.8" W x 152.75"H	Inside Print
7	74.8" W x 146.5" H	Outside Print Right Side Tower
8	74.8" W x 172.25"H	Outside Print
9	74.8" W x 172.25"H	Inside Print
10	74.8" W x 172.25"H	Outside Print
11	74.8" W x 172.25" H	Inside Print
12	74.8" W x 191.7" H	Inside Print Lower Bridge
13	74.8" W x 230.7" H	Inside Print Upper Bridge

Frame Assembly

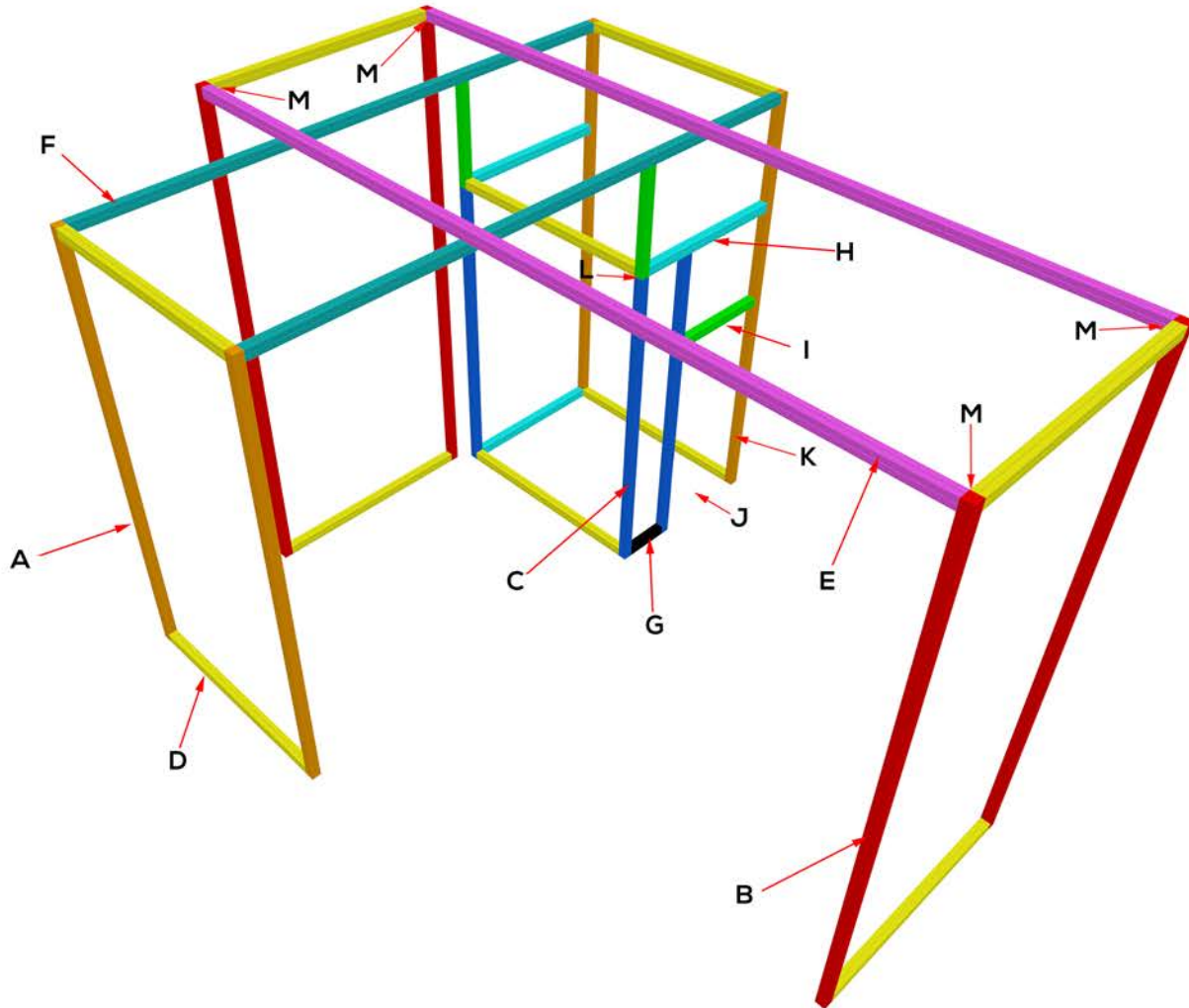

REF	SKU	QTY	LENGTH
A	CABO-80	8	76.4"
B	CABO-80	8	86.1"
C	CABO-80	6	56.9"
D	CABO-80	10	74.8"
E	CABO-80	6	76.9"
F	CABO-80	4	95.85"
G	CABO-80	1	16.3"
H	CABO-80	3	55.3"
I	CABO-80	3	35.8"
J	CABO-DOOR	1	n/a
K	CABO-80-ADPT	16	n/a
L	CABO-CS	4	n/a

Lock/Connector Instructions

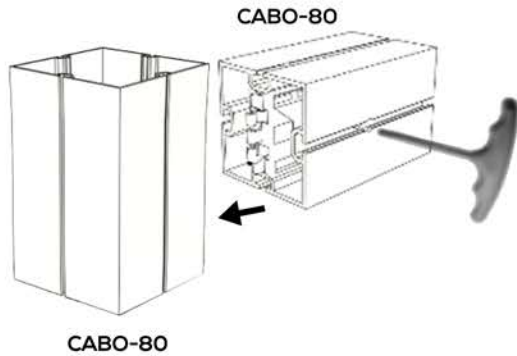

CABO-80 Profile Connection

1. Line up lock with system groove on vertical profile
2. Insert teeth of lock into groove
3. Use torx tool to tighten lock (turn clockwise to tighten)

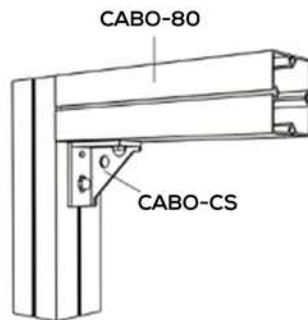

CABO-CS Installation

1. Insert hammerhead screws through holes in CABO-CS (make sure "hook" side of screw is on the flat side of the bracket)
2. Place CABO-CS into inside 90° corner of profiles and insert hammerhead screw into system groove on profile
3. Tighten nut on hammerhead screw to secure CABO-CS into place

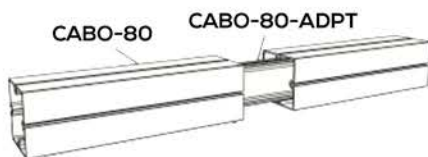

CABO-80-ADPT Connection

1. Insert CABO-80-ADPT into one CABO-80 profile
2. Slide opposing CABO-80 profile onto CABO-80-ADPT
3. Tighten screws on CABO-80-ADPT to secure profiles in place

SEG Attachments

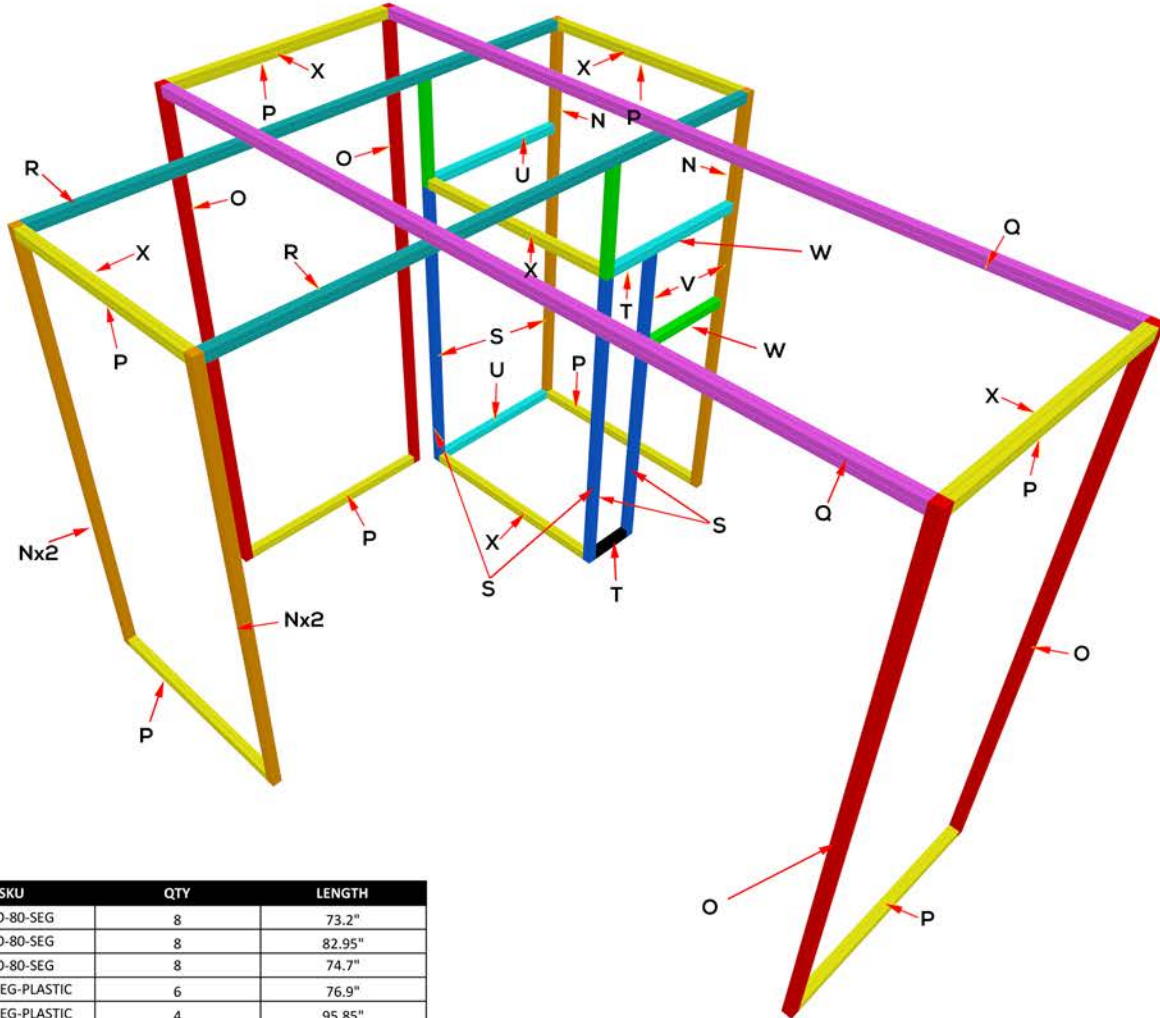

REF	SKU	QTY	LENGTH
N	CABO-80-SEG	8	73.2"
O	CABO-80-SEG	8	82.95"
P	CABO-80-SEG	8	74.7"
Q	CABO-SEG-PLASTIC	6	76.9"
R	CABO-SEG-PLASTIC	4	95.85"
S	CABO-SEG-PLASTIC	12	55.3"
T	CABO-SEG-PLASTIC	2	16.3"
U	CABO-SEG-PLASTIC	2	55.2"
V	CABO-SEG-PLASTIC	2	35.7"
W	CABO-SEG-PLASTIC	2	31.8"
X	CABO-SEG-PLASTIC	6	74.7"
Y	CABO-HHS	130	n/a

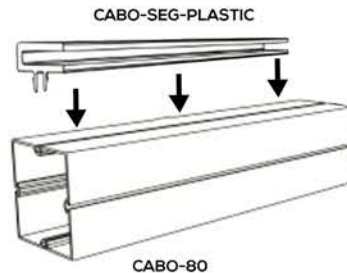

CABO-SEG-PLASTIC Installation

1. Line up clip of CABO-SEG-PLASTIC with system groove of profile
2. Press CABO-SEG-PLASTIC down to lock into place.



CABO-80-SEG Installation

1. Unscrew CABO-HHS and feed through holes on CABO-80-SEG
2. Line up CABO-HHS with system groove on profile CABO-80-SEG will attach to
3. Tighten CABO-HHS clockwise to secure