

Formulate Master 5ft Dynamic Backlit Display

FMLT-DYCL-W55-01

The Formulate® 5' Dynamic Backlit Display adds visual intrigue to any event by coupling a programmed LED light curtain with an aluminum tube frame and captivating fabric graphics. Assembly is simple with light curtains that easily hook into the top and bottom of the frame and zipper pillowcase fabric graphics. The light pattern and timing is customized to bring the display to life. Stock animations are also an option.

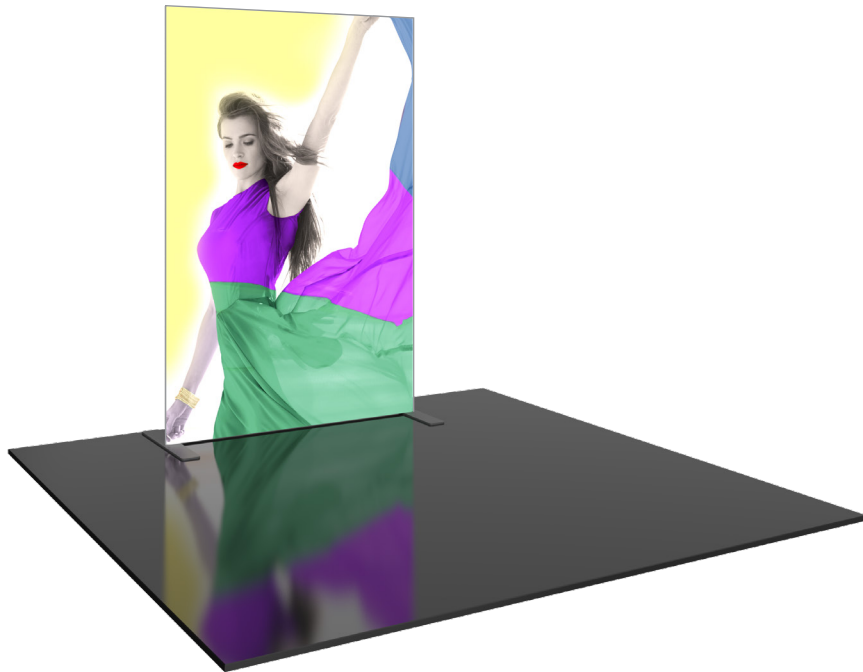

features and benefits:

- State-of-the-art 50mm aluminum tube frame with bungee snap-button assembly
- Dynamic LED light curtains easily attach to the frame at the top and bottom
- Single sided pillowcase fabric graphic is printed on backlit textile and includes an opaque backer
- Kit includes: one frame, one single sided dye-sublimated zipper pillowcase graphic, one light curtain, one transformer, and one wheeled OCE molded storage case
- Easy to store and ship
- Lifetime frame warranty against manufacturer defects
- 90 day light warranty

dimensions:

Hardware	Graphic
Assembled unit: 63.71" w x 92" h x 25.59" d 1618mm(w) x 2337mm(h) x 649mm(d)	Refer to related graphic template for more information.
Approximate weight without case: 48 lbs / 22 kg	One year warranty
	Visit: https://www.theexhibitorshandbook.com/download-graphic-templates

Shipping	additional information:			
Packing case(s): 1 OCE	Graphic material: Dye-sublimation zipper pillowcase fabric - Backlit textile with opaque backer			
Shipping dimensions: OCE: Expandable case length (l) may vary 40"-66"l x 18"h x 18"d 1016mm-1677mm(l) x 458mm(h) x 458mm(d)	Lighting Power Requirements:			
Approximate total shipping weight: 76 lbs / 35 kg	<table border="1"> <tr> <td>Watts: 600W</td> <td>Amps: 12A</td> <td>Volts: 115-230V</td> </tr> </table>	Watts: 600W	Amps: 12A	Volts: 115-230V
Watts: 600W	Amps: 12A	Volts: 115-230V		
	When included in a larger order, a different packaging solution will be provided to accommodate all contents of the order. Individual packaging may no longer be provided.			

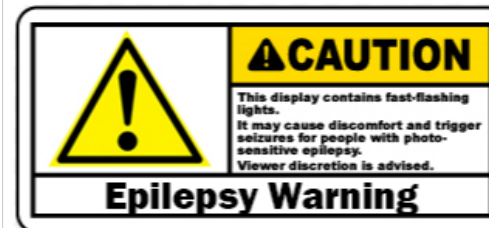

This product may include the following materials for recycle:
aluminum, select wood, fabric, cardboard, paper, steel, and plastics.

We are continually improving and modifying our product range and reserve the right to vary the specifications without prior notice. All dimensions and weights quoted are approximate and we accept no responsibility for variance. E&OE. See Graphic Templates for graphic bleed specifications.

Included In Your Kit

Tools, Components, & Connectors

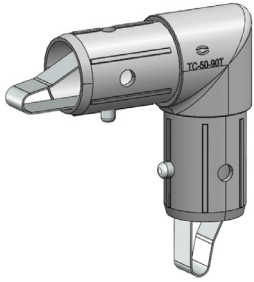

TC-50-90T x2

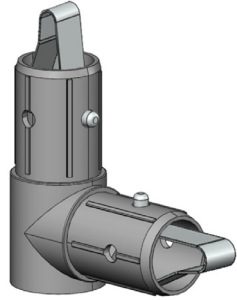

TC-50-90B x2

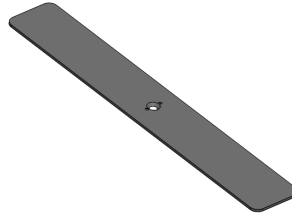

LN114-S2-650 x2

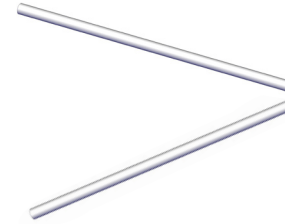

FMLT-BL-WS5-01-SIDE x2



FMLT-BL-WS5-01-T2 x2



LED-DYCL-CURTAIN LIGHT x2



FMLT-BL-CURTAIN-TRANS-2 x1



HEX-KEY-5MM x1



ES30-90-SCRW x2



LED-DYCL-CONTROLLER x1

Graphics



FMLT-DYCL-WS5-01-G x1

Exploded View

FMLT-DYCL-WS5-01

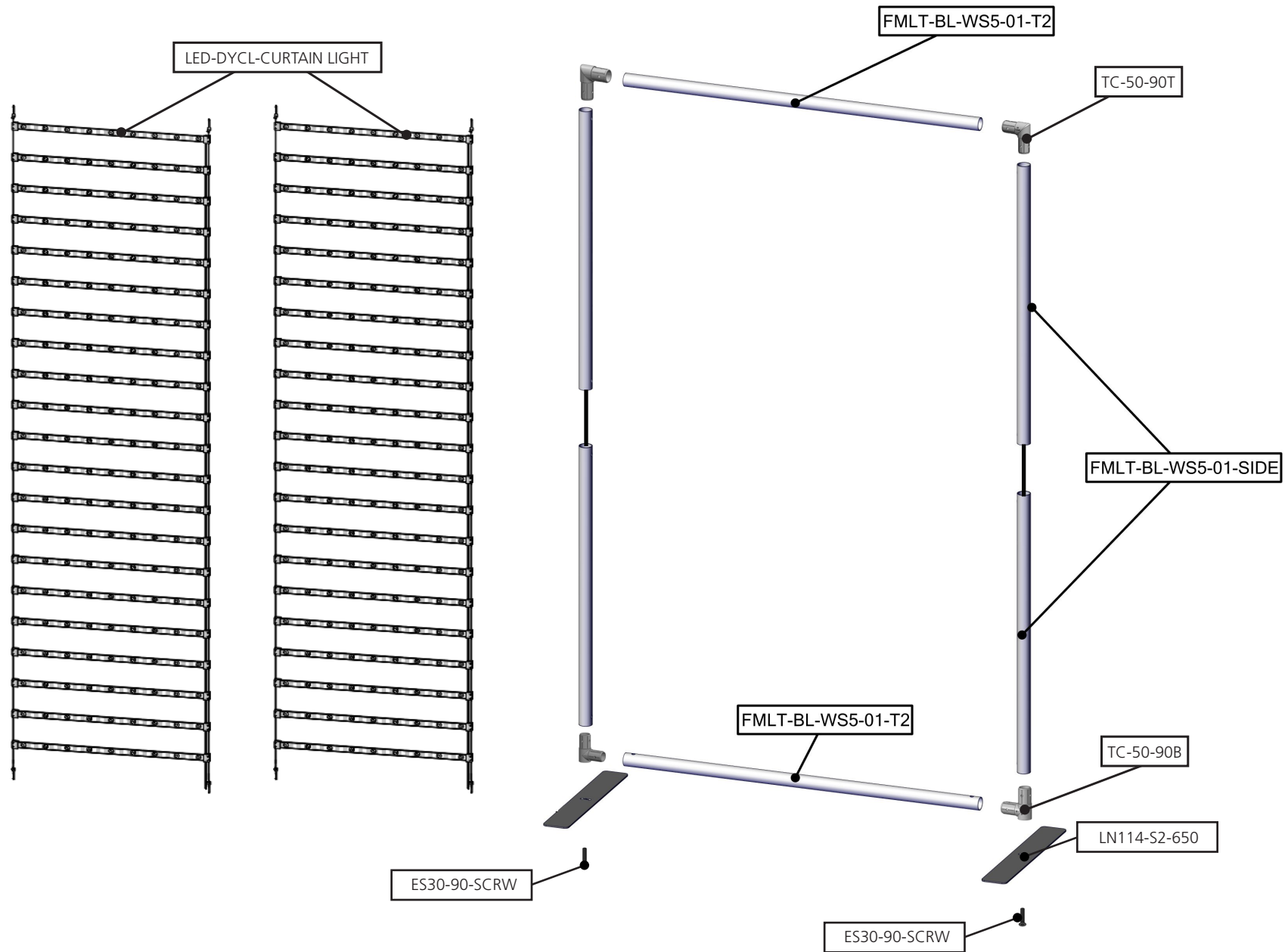

Labeling Diagram

FMLT-DYCL-WS5-01

Assemble Note:

Follow number labels for connection points. See example on the right.

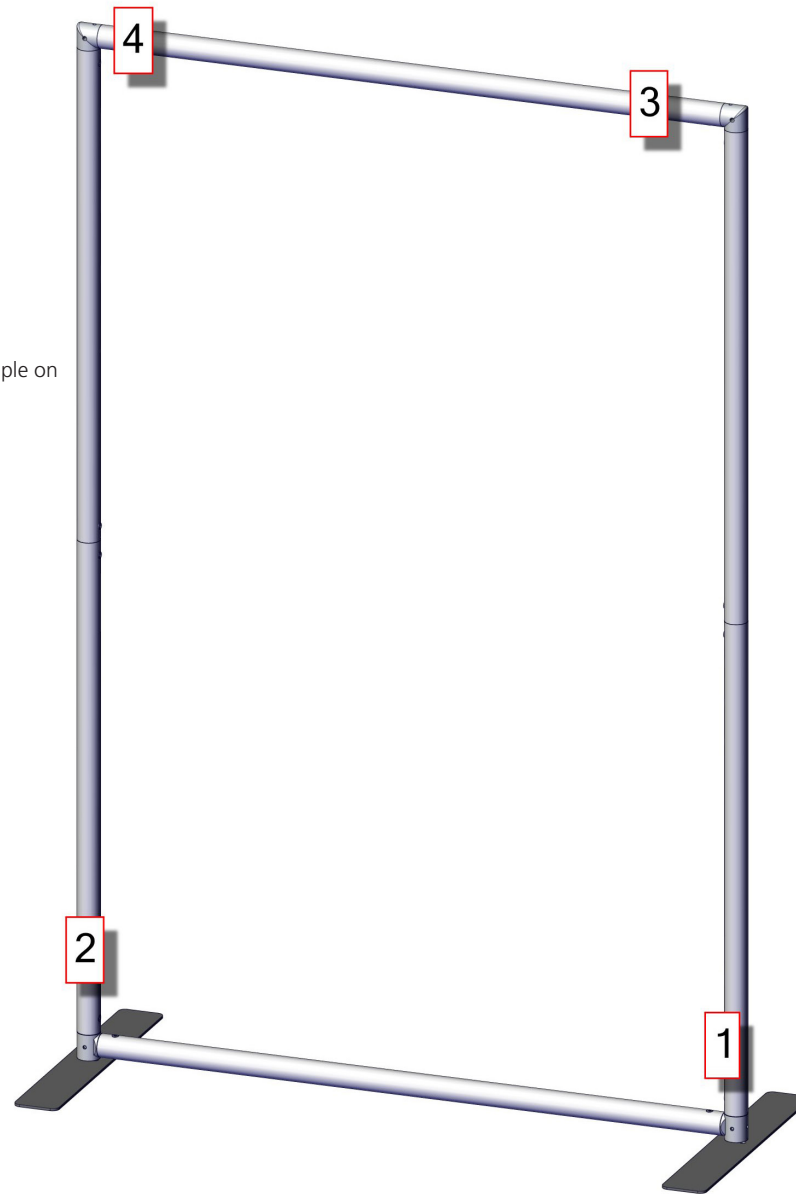

Connection Methods

Connection Method 1: TC-50-90T

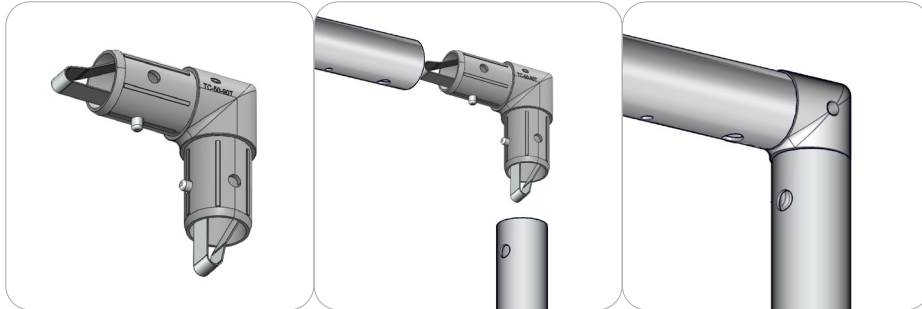

Take the plastic connector and make sure the snap buttons are in proper position for the frame tube holes. Simply press the snap button with your thumb and carefully slide the tube onto the connector. The snap button should pop through. Some twisting may be necessary to assure the snap button has popped all the way through the tube hole. Do not force the connection and be careful with the tube edges, they may be sharp.

Connection Method 2: TC-50-90B

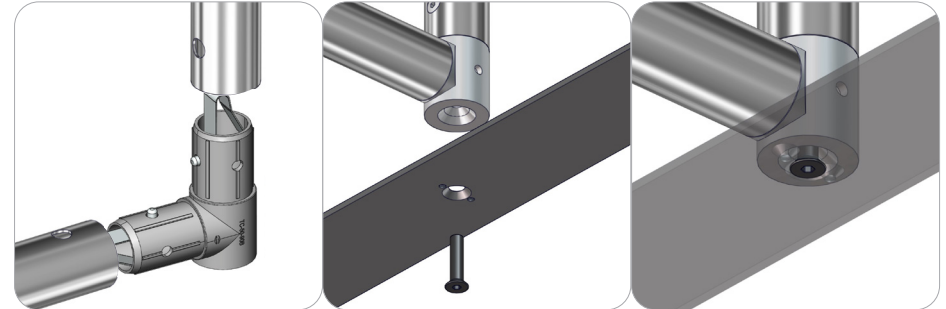

Take the plastic connector and make sure the snap buttons are in proper position for the frame tube holes. Simply press the snap button with your thumb and carefully slide the tube onto the connector. The snap button should pop through. Some twisting may be necessary to assure the snap button has popped all the way through the tube hole. Do not force the connection and be careful with the tube edges, they may be sharp.

Connection Method 3: SNAP BUTTONS



For snap button connections, locate the snap button on the connector or swage tube. Locate the hole on the corresponding tube. Press the snap button with your thumb and slide the tube and connector together so that the snap button snaps fully into the lock hole. To disassemble, press the snap button and pull apart.

Frame Assembly

Step by Step

Step 1.

Unzip and remove the bungee connected tubes from the bag and connect the tubes using the push-buttons. See Connection Method 3 for more details.

See Connection Method 1 for the top of the frame, and Connection Method 2 for the bottom of the frame.

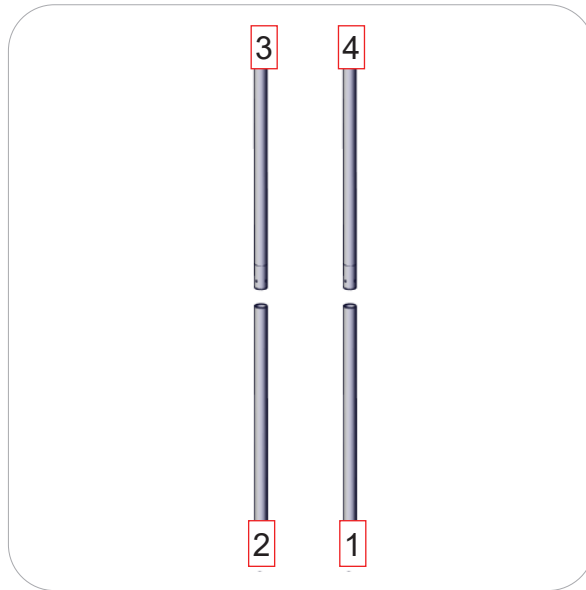
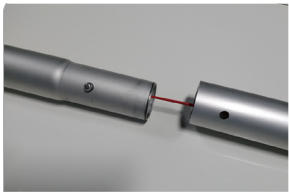

Step 2.

Remove the non-bungeed tubes from the bag and match the labeled numbers to the ends of the tubes that you've already placed on the ground.

See Connection Method 1 for the top of the frame, and Connection Method 2 for the bottom of the frame.

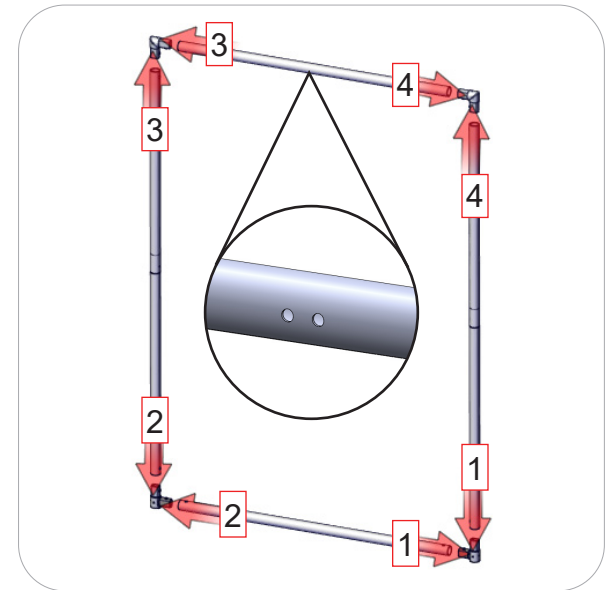

Step 3.

Attach the feet by removing the bolt from the bottom of the upright tubes, placing the foot against the frame, and inserting the bolt through the foot and into the frame so the bolt head sits in the countersunk hole and is flush with the foot.

Hand tighten and lay the feet so they sit flat against the floor on their side.

Reference Connection Method 2 for more details.

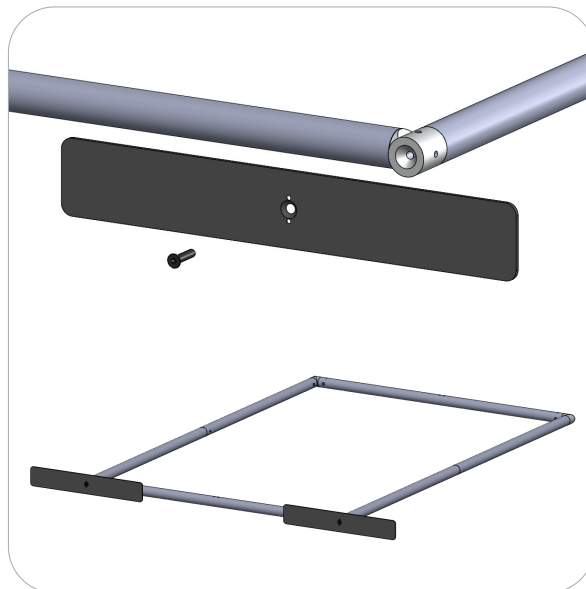

Light Curtain Attachment

Step by Step

Step 4.

Remove one of the light curtains from its box and bring it to the frame.

Check the plugs of the curtain; with the male end toward the top of the frame, unroll the curtain with the bulbs facing down.

Be sure to keep the padding and packaging to protect the lights during storage and shipping.



Step 5.

Hook the light curtain clips into the two holes at the top of the frame closest to the side.

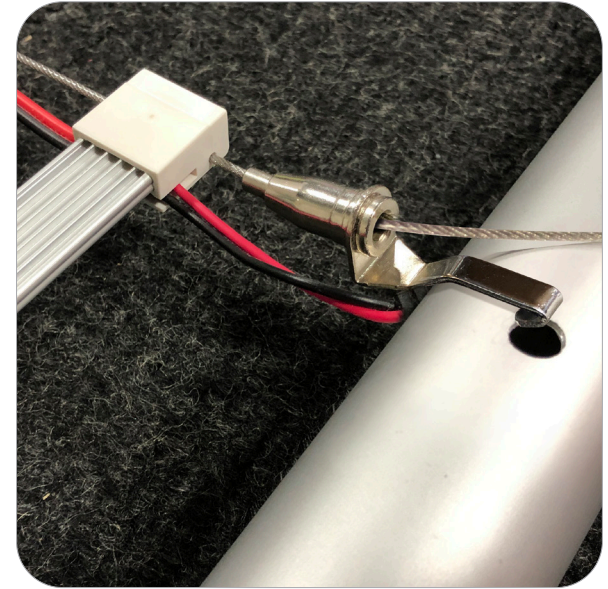

Step 6.

Unroll the light curtain and leave the bottom loose.

Repeat Steps 4-6 until all curtains have been hooked to the top of the frame.



Step 7.

Insert any excess cable of the light curtains into the hole of its connected hook to prevent it from pushing against the graphic.

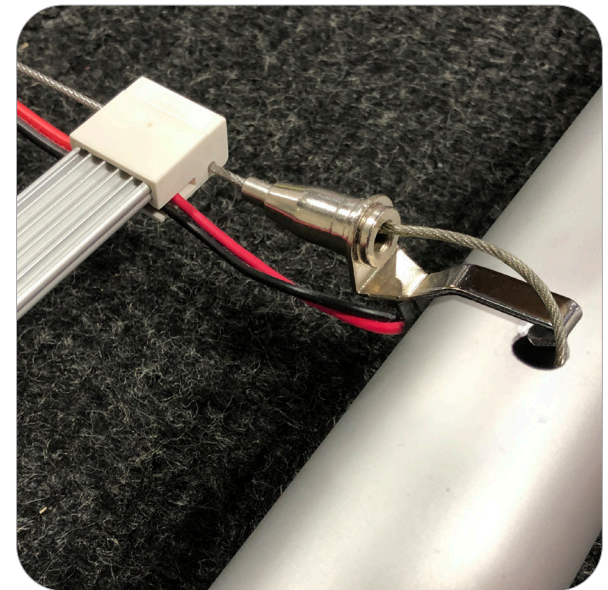

Light Curtain/Graphic Attachment

Step by Step

Step 8.

Move to the bottom of the frame and insert the light hooks from the bottom of the curtains into the holes.

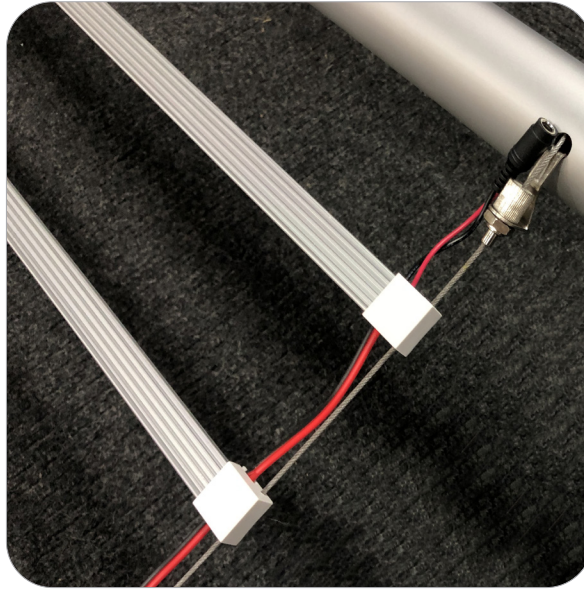

Step 9.

Tighten the curtain light cables so that the curtain is taugth with the frame and insert excess cable into the bottom hole to prevent it from pushing against the graphic.

See next page for in-depth instructions on tightening the curtain.



Step 10.

Rotate the feet to their correct, perpendicular orientation.

With the frame still laying on the ground, pull the pillowcase graphic over the top of the frame to begin fitting.

Make sure the graphic is being installed evenly down both sides of the frame.



Step 11.

Once the graphic has reached 1/4 to 1/2 way down the frame, you can stand the frame upright to assist in installing the graphic the rest of the way down the frame.

Roll up the padding for the lights and store in the light curtain boxes to use during dismantle.



Adjusting Light Curtain Tension



Step 1.
Locate the curtain light hook button.

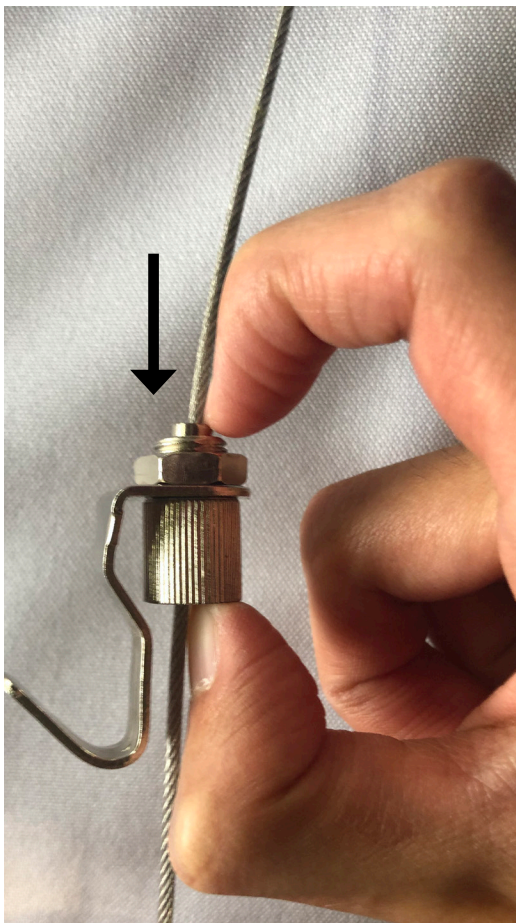

Step 2.
Press down on the button releasing pressure from the curtain light cable.

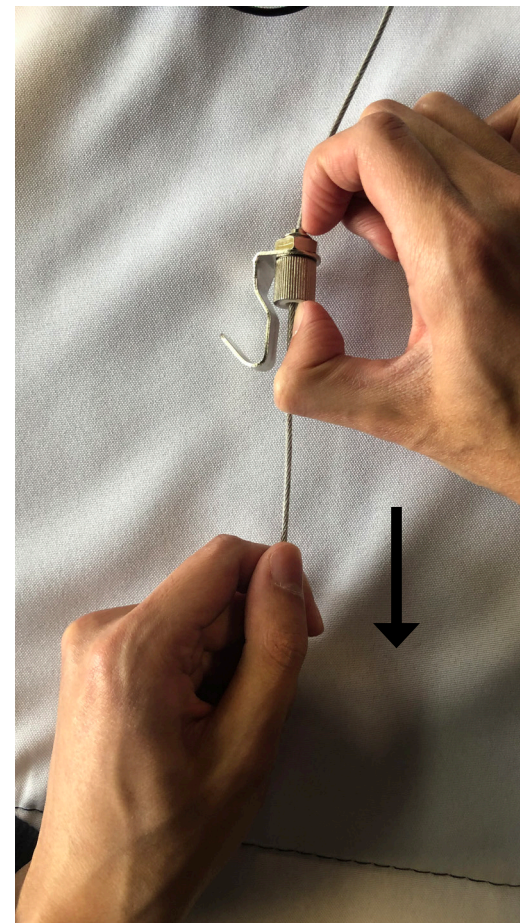

Step 3.
While pressing down on the button pull the cable away from the curtain light until it is tight with the frame.

Light Connection

Step by Step

Step 12.

1

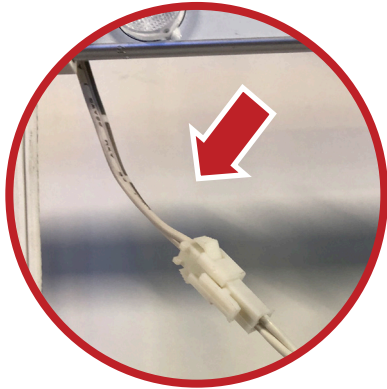

Connect the light curtains together

2



Connect the white, male end of the transformer cord into the black female end of each light curtain's cord.

3



Plug in controller & light curtain to the power supply.

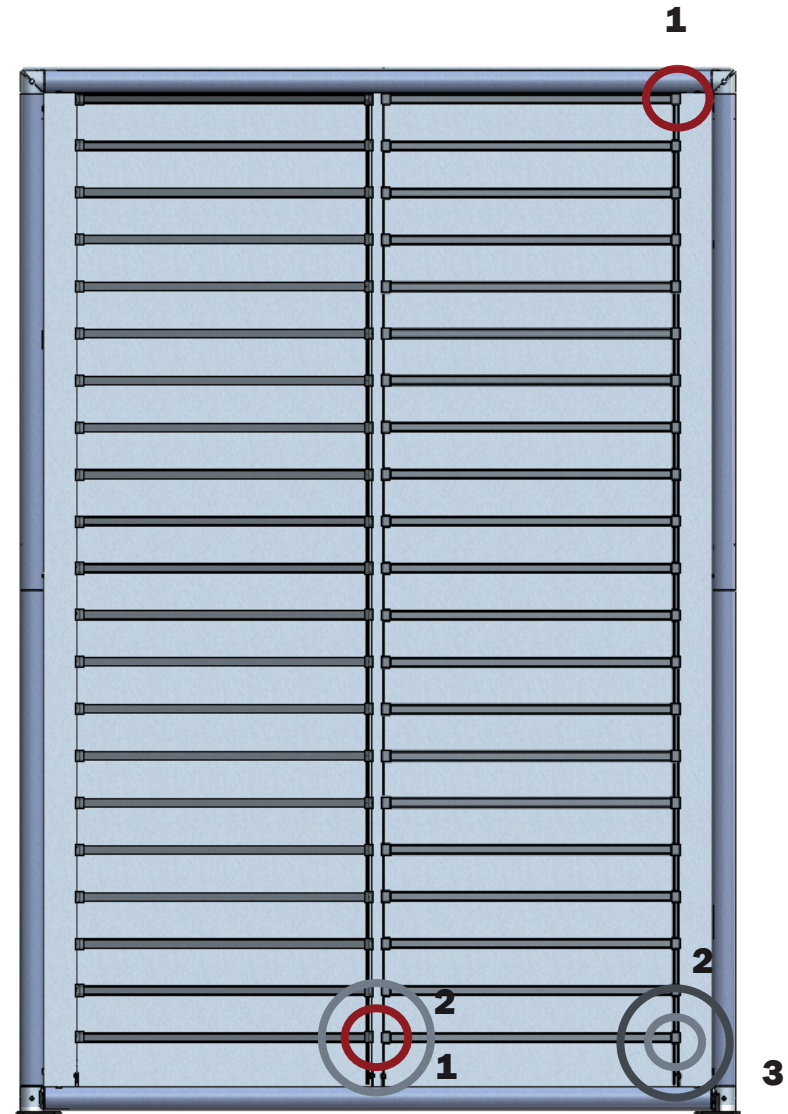

Light Connection

Step by Step

Step 13.

Zip the bottom of the graphic; one section for each light curtain.



Step 14.

Plug in the transformer.

Do not cover or hinder airflow to the transformer as it needs air circulation to work properly.

Set up is complete.

Note: In the US, set the transformer to 115v; International, set it to 230v.



Dynamic Curtain Light Controller

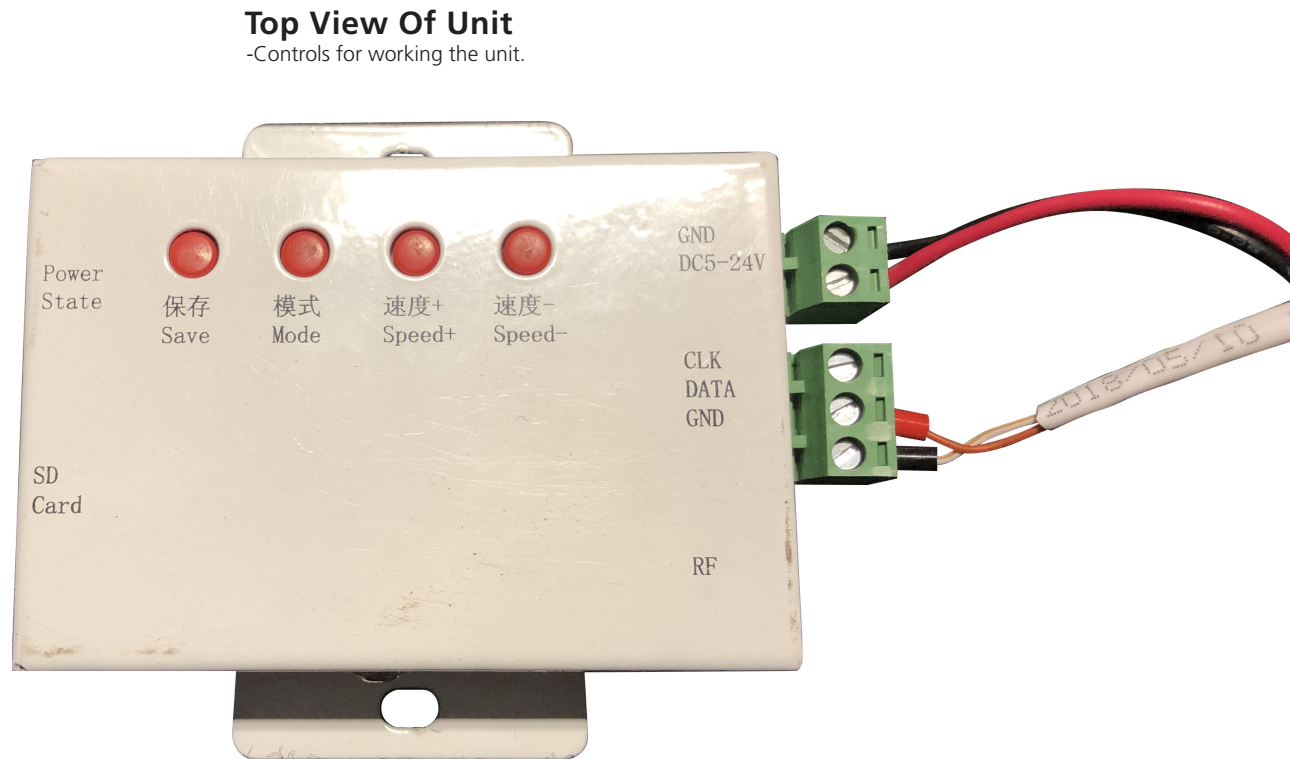
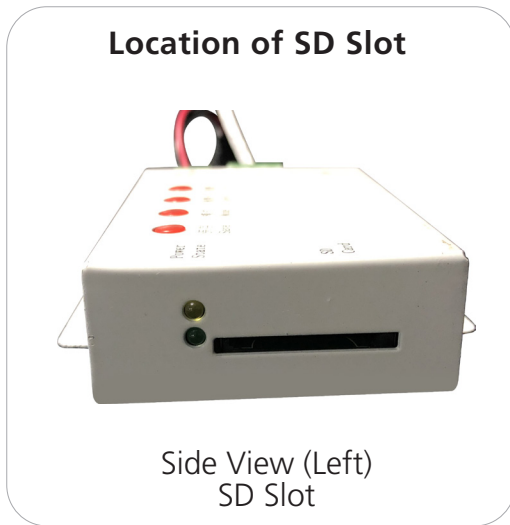

Save:
Unused

Mode:
Unused

Speed+:
Increase the speed
at which the
animation runs

Speed-:
Decrease the speed
at which the
animation runs