

MODify: NTable 01

Total graphic area: 30.5"w X 35.25"h
Total visual area: 26.5"w X 31.25"h

Please be sure to include the 2" bleed around the perimeter. Do not design any critical elements (text, logos, etc.) within 2" of the edge (see light gray for safe area). Please keep in mind that the graphic will also be obstructed by anything displayed on the shelves.

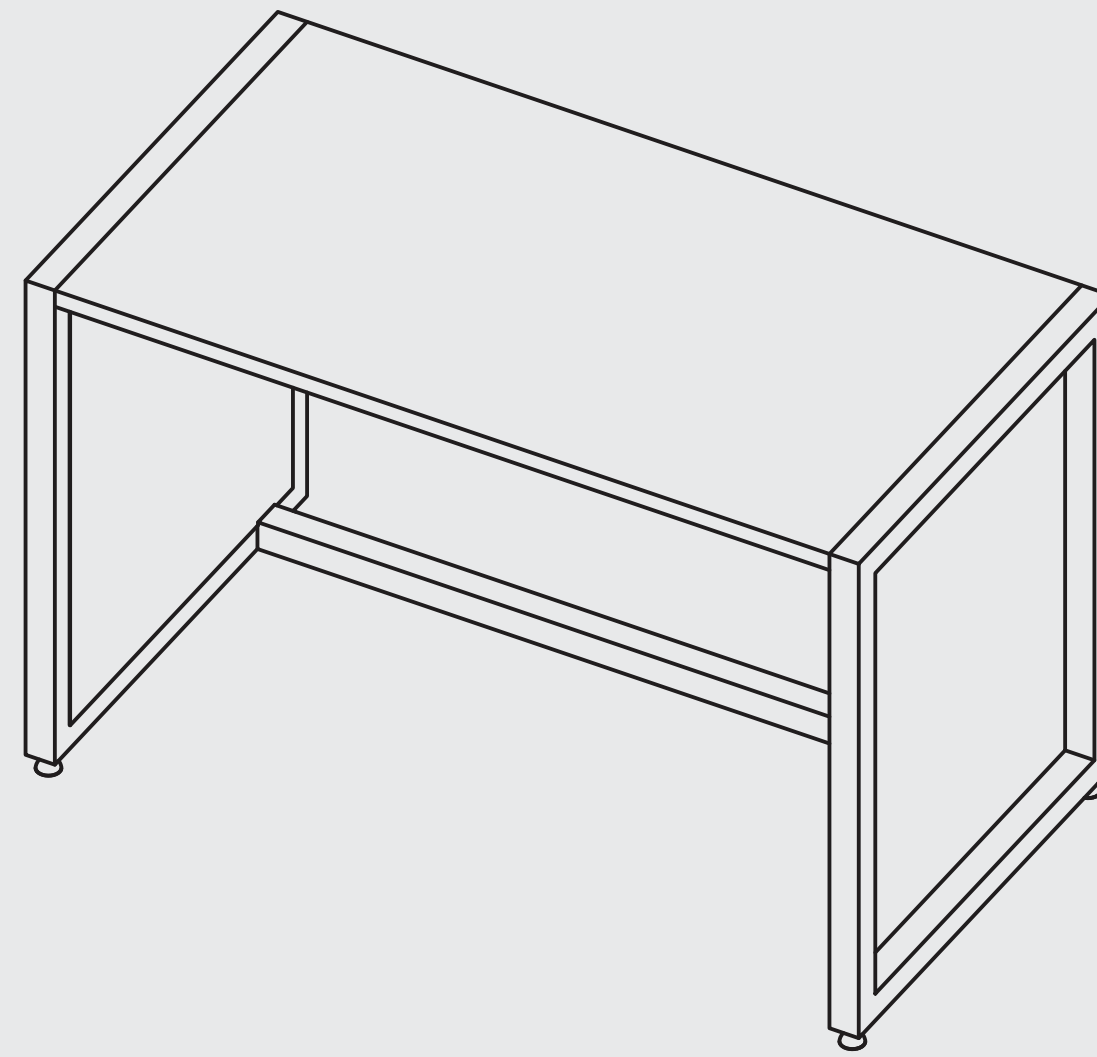

General Art Guidelines:

- CMYK Color Mode
- All Solid Coated Pantone colors should be called out in the art as spot colors
- Embed all images and support files
- Resolution must be 100-120 ppi
- All fonts must be created to outlines
- Do not scale artboard
- Background color/images must bleed to the edge of artboard
- Do not use spot colors from template in your artwork as they will not print

PANEL A

PANEL B

bleed area

trim line

safe area