

# MODify Double Sided Kit 04

MODify™ is a one-of-a-kind Modular Merchandising System that is made up of interchangeable fixtures and accessories that can be easily assembled, disassembled, and rearranged to create a variety of different display configurations. The MODify system incorporates SEG push-fit fabric graphics that enable you to brand, promote and merchandise with ease.

MODify Double Sided Kit 04 features three double-sided slatwall panels and six SEG push-fit graphic headers. Create the perfect layout of fixtures such as hooks, shelves, waterfalls and bars for this adaptable retail display.



We are continually improving and modifying our product range and reserve the right to vary the specifications without prior notice. All dimensions and weights quoted are approximate and we accept no responsibility for variance. E&OE. See Graphic Templates for graphic bleed specifications

## features and benefits:

Base Kit includes:

- Frame, slatwall, shelf and base colors in kit are all the same, your choice of all white, black, or silver
- Heavy-duty aluminum frame, steel base
- Steel, slotted uprights
- Three double sided 36"W x 96"H slatwall panels
- Six 36"W x 12"H SEG push-fit graphic headers
- Non-rolling base
- Display is easy to assemble and install
- Lifetime hardware warranty against manufacturer defects

Optional Accessories Include:

- Towel bars.
- Faceout bars
- Waterfalls
- U bars
- Slatwall hooks
- Shelves

## dimensions:

### Hardware

Assembled unit:

110"W x 96"H x 37.5"D  
2794mm(w) x 2438.4mm(h) x 952.5mm(d)

Approximate Weight:  
342 lbs / 155.129 kg

### Shipping

Packing case(s):  
1 Box

Shipping dimensions:  
(96" L x 14" H x 24" D)  
2438.4mm(l) x 355.6mm(h) x 609.6mm(d)

Approximate shipping weight:  
406 lbs / 184.159 kg

## additional information:

### Graphics

Graphic material: Dye-sublimated fabric

See graphic templates for graphic sizes.

Refer to related graphic templates for more information Visit:

<https://www.theexhibitorshandbook.com/downloads/download-graphic-templates>  
or click here

Powder coat color options:



white

black

silver

Wood laminate color options:

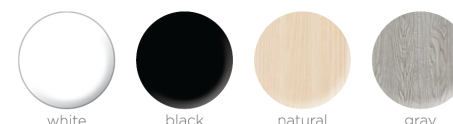

white

black

natural

gray

# MODify Accessories

All Accessories available in white, black, or silver

## Slotwall Accessories

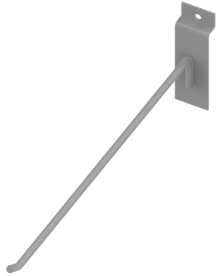

MFY-SLT-HK  
4", 6", 8", 10" & 12"

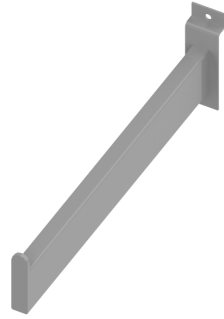

MFY-SLT-FC  
6", 8", 10" & 12"

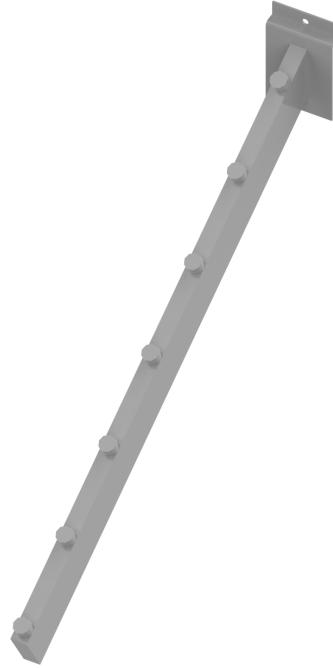

MFY-SLT-WTR-16-7

## U-Bar Accessories

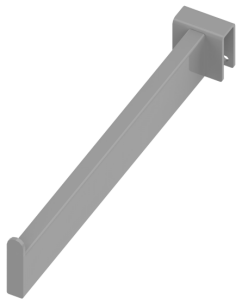

MFY-TWL-FC  
6", 8" & 10"

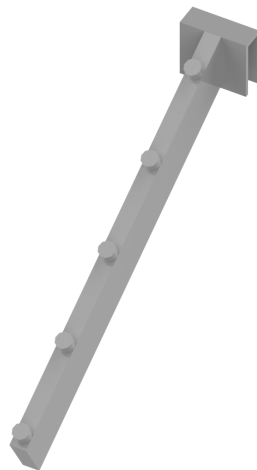

MFY-UBR-FC  
6", 8" & 10"

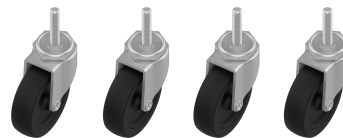

MFY-CSTR-4-PK

## Shelf and Hanger Bars

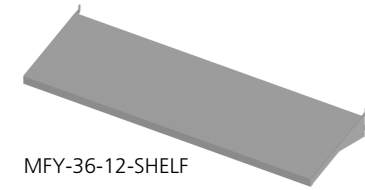

MFY-36-12-SHELF

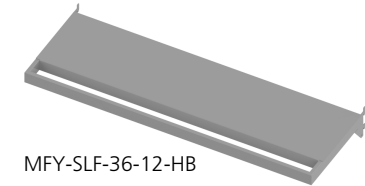

MFY-SLF-36-12-HB

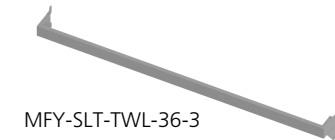

MFY-SLT-TWL-36-3

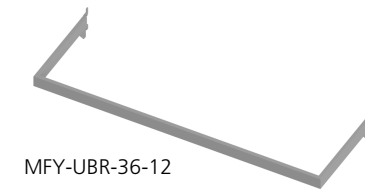

MFY-UBR-36-12

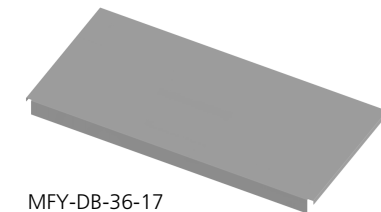

MFY-DB-36-17

# Tools Required



MULTI HEX KEY  
(INCLUDED)



PHILLIPS SCREW DRIVER  
(NOT INCLUDED)



9/16" SOCKET WRENCH  
(NOT INCLUDED)

## How to Apply & Remove Graphics

Installation and removal of SEG graphics is easy!

**Installation:** Push the SEG bead into each corner of the frame (1-4) with your thumb, then push the SEG bead into the middle of the run (5-8) and work your way around the perimeter of the frame until all beading is pushed in properly; if necessary, go around the perimeter again to ensure beading is secure in the extrusion profile.

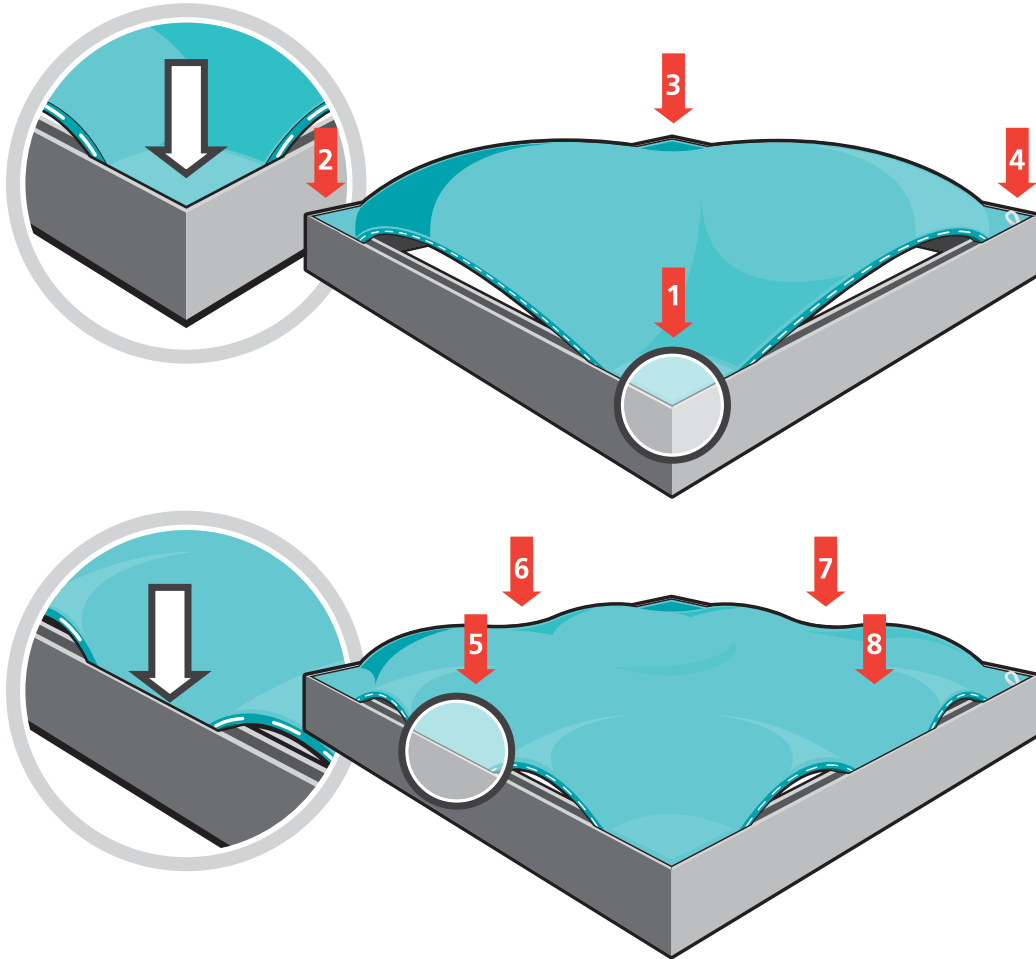





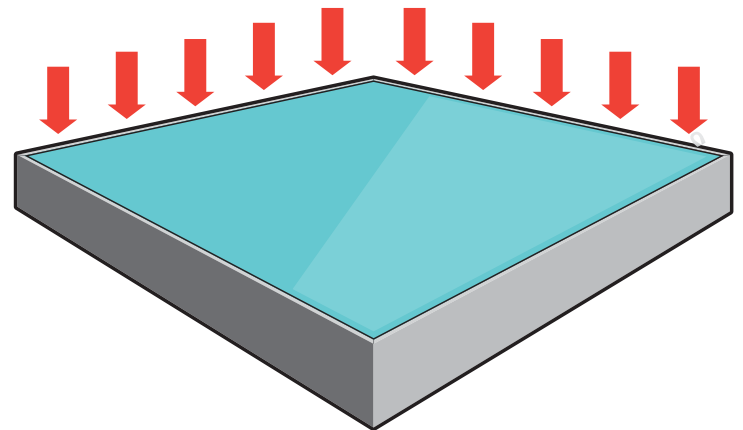



**Note:** Keep the set up area clean by using a drop cloth, washing hands before set-up or by wearing gloves.

**Removal:** Use the pull tab located on the graphic and gently pull the graphic from the frame, going around the perimeter.



## Graphics Storage & Care

Graphics should be folded with the graphic facing inward and stored in a zip lock /sealable plastic bag. Spot clean by wiping with a damp white cloth. If washing is necessary, use a commercial size front-loading washing machine, gentle cycle with cool water. Line dry flat. Dry cleaning is NOT recommended to prevent shrinkage.

QTY	IMAGE	DESCRIPTION
4		3/8-16 x 2.5-3"L bolt
1		2350MM (92.52in) OF 833 DOUBLE SIDED UPRIGHT CLOSED EXTRUSION
2		2350MM (92.52in) MIDDLE UPRIGHT
1		2350MM (92.52in) LEFT UPRIGHT
2		947MM (37.28IN) MIDDLE SUPPORT LEG
1		947MM (37.28IN) LEFT SUPPORT LEG
1		947MM (37.28IN) RIGHT SUPPORT LEG
6		1973MM (77.68in) OF SWC EXTRUSION

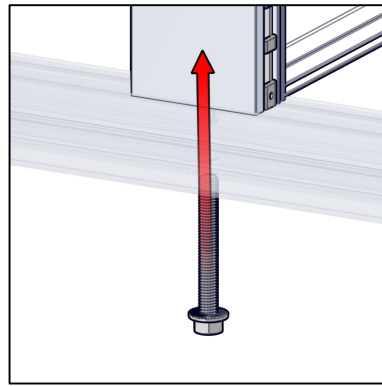

MFY-BOLT-375-16-2.5

## SETUP INSTRUCTIONS

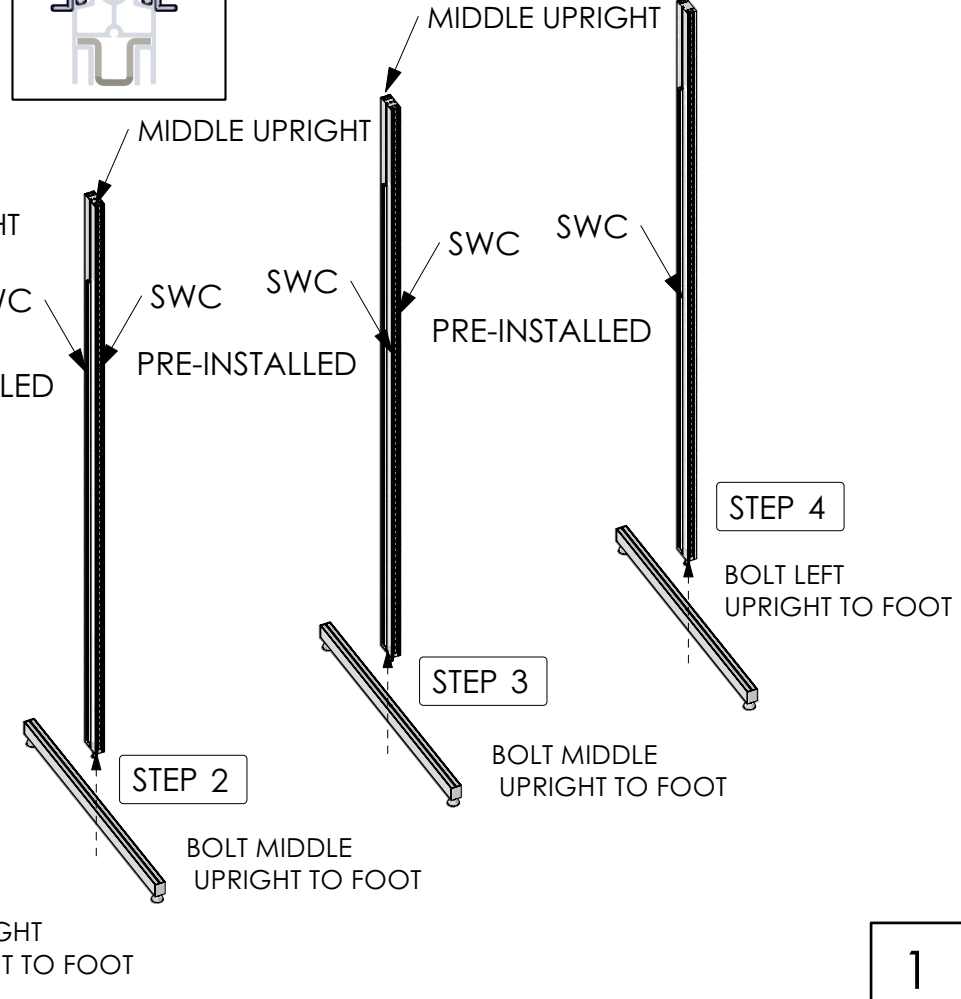
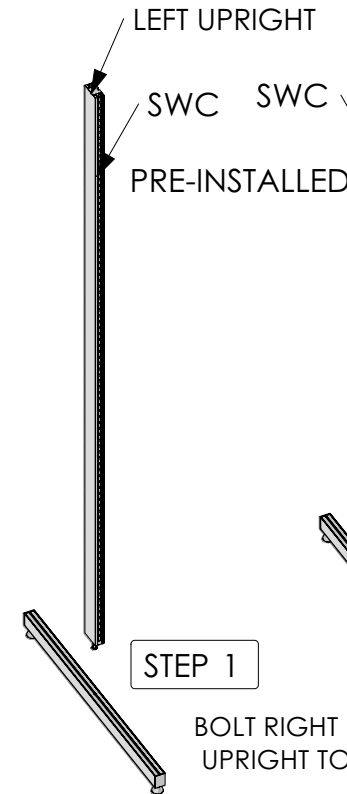
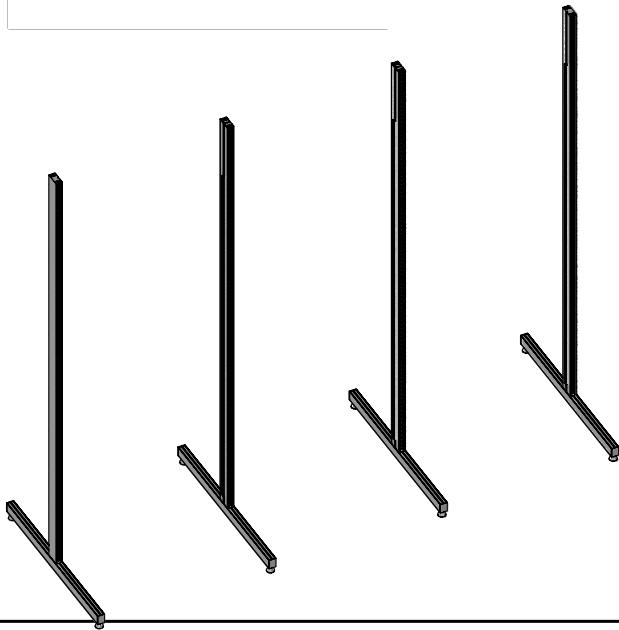
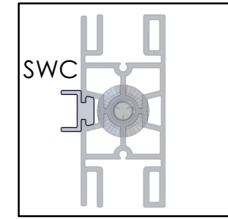
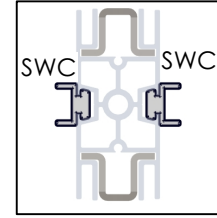
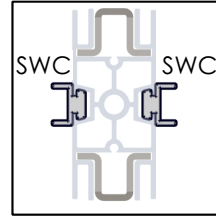
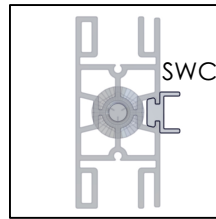
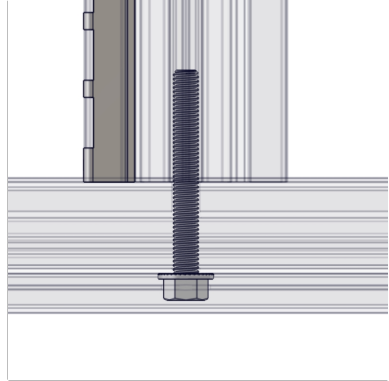

STEP 4

BOLT LEFT UPRIGHT TO FOOT

STEP 3

BOLT MIDDLE UPRIGHT TO FOOT

STEP 2

BOLT MIDDLE UPRIGHT TO FOOT

STEP 1

BOLT RIGHT UPRIGHT TO FOOT

QTY	IMAGE	DESCRIPTION
4		883MM (34.7in) OF SINGLE SIDED SEG EXTRUSION -WITH CAM LOCKS BOTH ENDS
4		883MM (34.7in) OF SWC EXTRUSION
13		879MM (34.61in) LENGTH OF SLOTWALL EXTRUSION

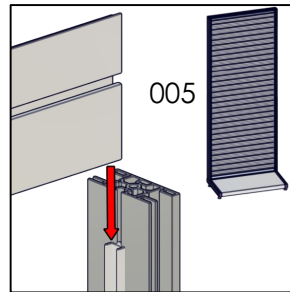

SLOTWALL EXTRUSION

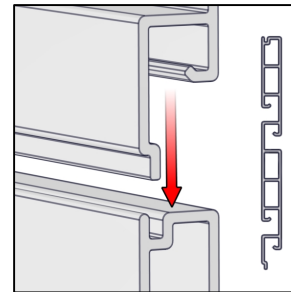

## SETUP INSTRUCTIONS

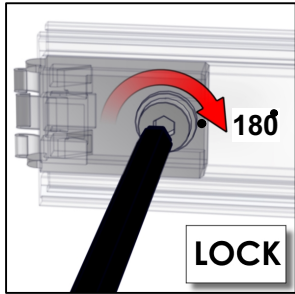

IMPORTANT!  
MAKE A HALF TURN  
TO LOCK EXTRUSIONS

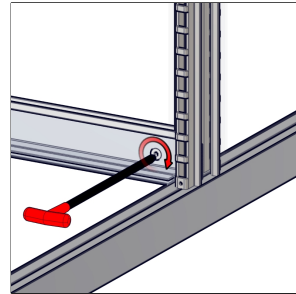

CROSS BRACE SITS  
ON SUPPORT LEGS

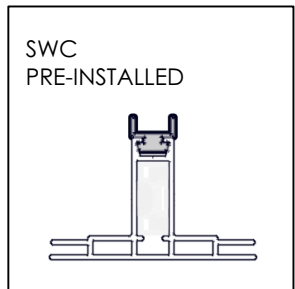

SLOT WALL TOP  
CHANNEL

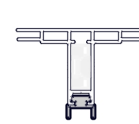
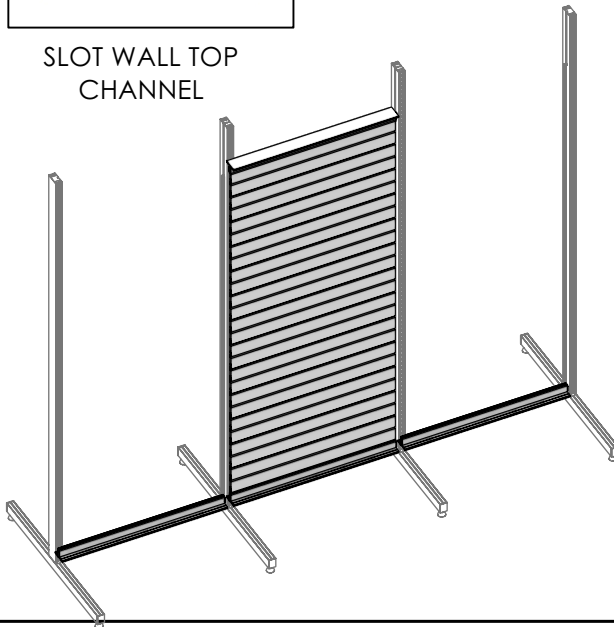

SWC  
PRE-INSTALLED

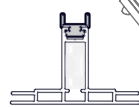

SWC  
PRE-INSTALLED

STEP 8

SLOTWALL  
EXTRUSION  
STACK 005-879

STEP 10

LOCK CROSS BRACE  
TO UPRIGHTS AND PLACE END  
CAPS

STEP 9

SLOTWALL

STEP 7

LOCK CROSS BRACE  
TO UPRIGHTS



STEP 6

LOCK CROSS BRACE  
TO UPRIGHTS

STEP 5

LOCK CROSS BRACE  
TO UPRIGHTS

NOTE: BOTTOM CROSS BRACE SITS ON TOP INSIDE  
EDGE OF LEFT AND RIGHT SUPPORT LEG

QTY	IMAGE	DESCRIPTION
26		879MM (34.61in) LENGTH OF SLOTWALL EXTRUSION
2		883MM (34.76in) OF SINGLE SIDED SEG EXTRUSION -WITH CAM LOCKS BOTH ENDS
2		883MM (34.76in) OF SWC EXTRUSION

## SETUP INSTRUCTIONS

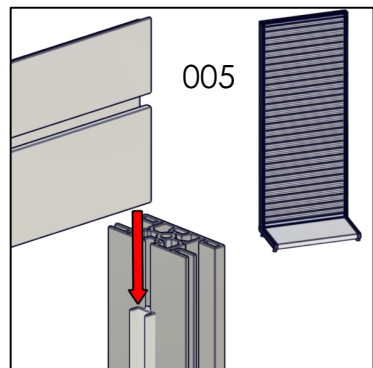

005

SLOTWALL 005

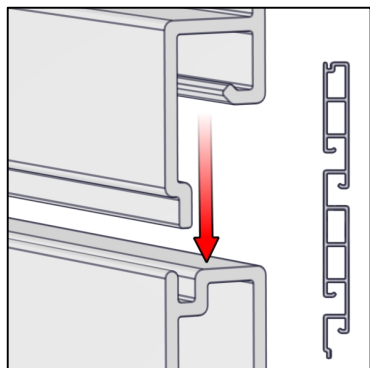

SWC PRE-INSTALLED

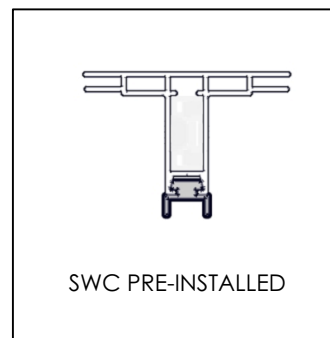

SWC PRE-INSTALLED

SLOT WALL BOTTOM CHANNEL

**STEP 11**  
SLOTWALL EXTRUSION STACK 005-879



**STEP 13**  
LOCK CROSS BRACE TO UPRIGHTS

**STEP 12**  
SLOTWALL EXTRUSION STACK 005-879



SWC PRE-INSTALLED

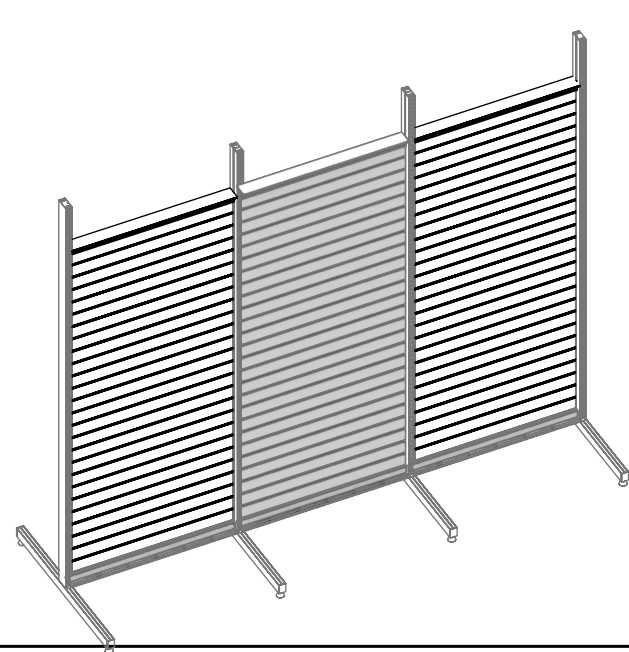

SLOTWALL

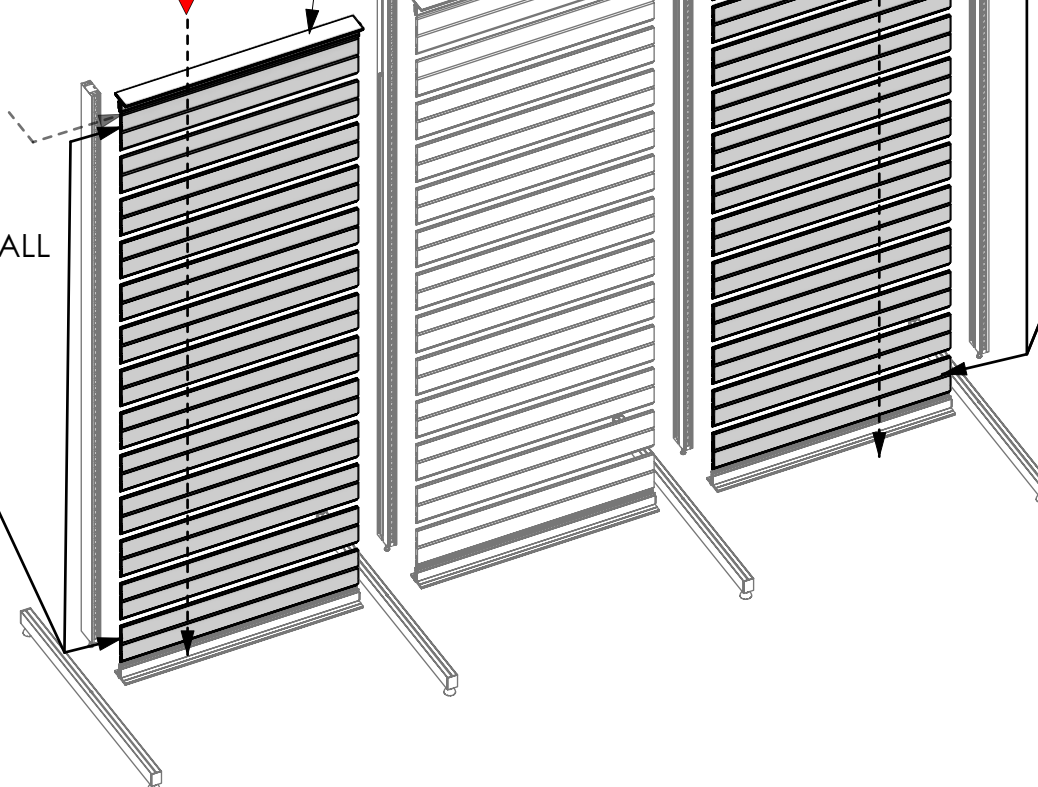

SLOTWALL

3		883MM (34.7in) OF SINGLE SIDED SEG EXTRUSION -WITH CAM LOCKS BOTH ENDS
2		7MM SEG PLASTIC END CAP FOR 833 EXTRUSION
2		7MM SEG PLASTIC END CAP FOR 832 EXTRUSION
		beading around perimeter & pull tab in bottom right corner (WITH 1/4" NOTCH LEFT & RIGHT BOTTOM HORIZONTAL SIDE CORNERS)

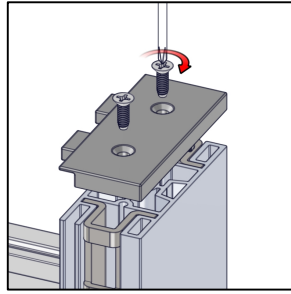

LOOSEN END CAP TO ATTACH TOP CROSS BRACE

## SETUP INSTRUCTIONS

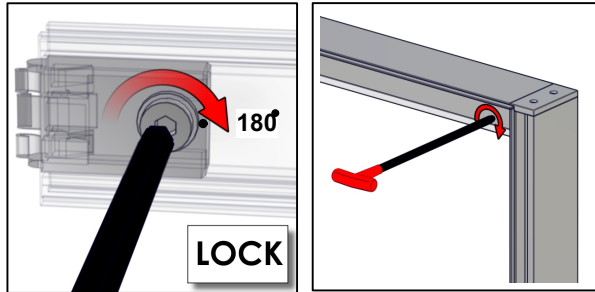

IMPORTANT! MAKE A HALF TURN TO LOCK EXTRUSIONS

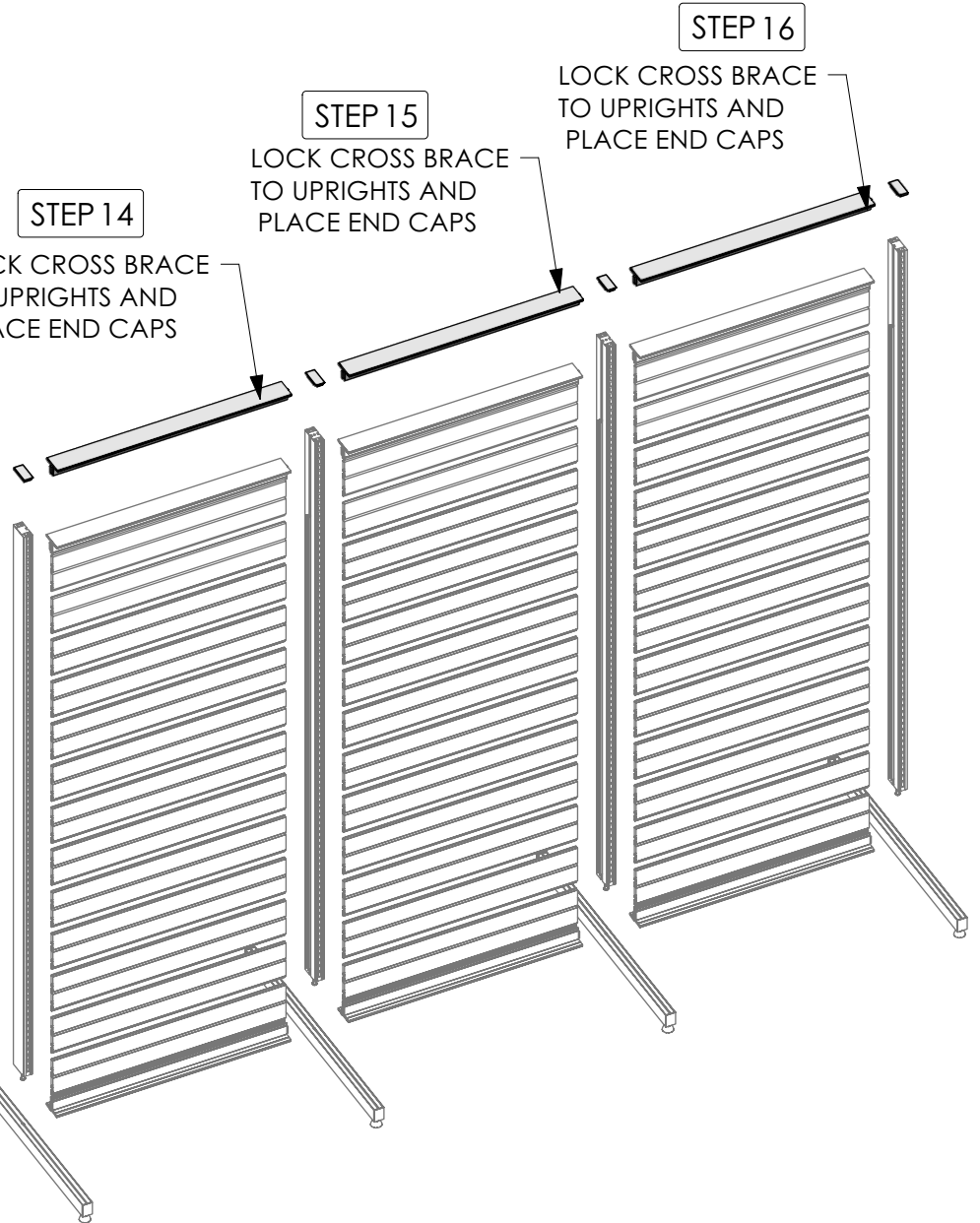

STEP 14

LOCK CROSS BRACE TO UPRIGHTS AND PLACE END CAPS



STEP 15

LOCK CROSS BRACE TO UPRIGHTS AND PLACE END CAPS

STEP 16

LOCK CROSS BRACE TO UPRIGHTS AND PLACE END CAPS



QTY	IMAGE	DESCRIPTION
6		36in WIDE X 17.25in DEEP - DROP-IN BASE PAN
6		(39.26 w X 15.07 h total size ) 35.26 w X 11.07 h finish size, Dye-sub print on Eclipse Blockout Stretch, single sided, sewn with FCE-2 silicone beading around perimeter & pull tab in bottom right corner (WITH 1/4" NOTCH LEFT & RIGHT BOTTOM HORIZONTAL SIDE CORNERS)

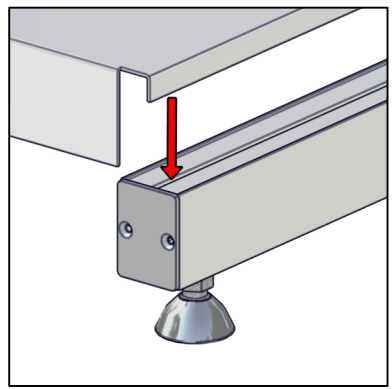

MFY-36-17-BASE-PAN

SETUP INSTRUCTIONS

STEP 17  
INSTALL GRAPHICS

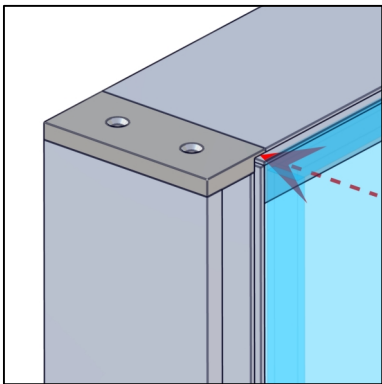

PRESS GRAPHIC INTO CORNERS

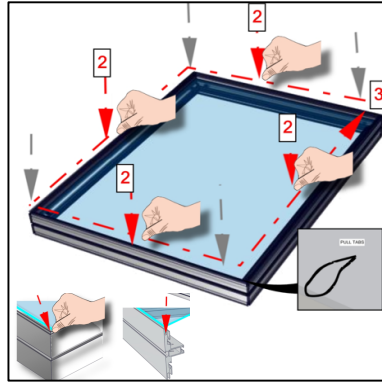

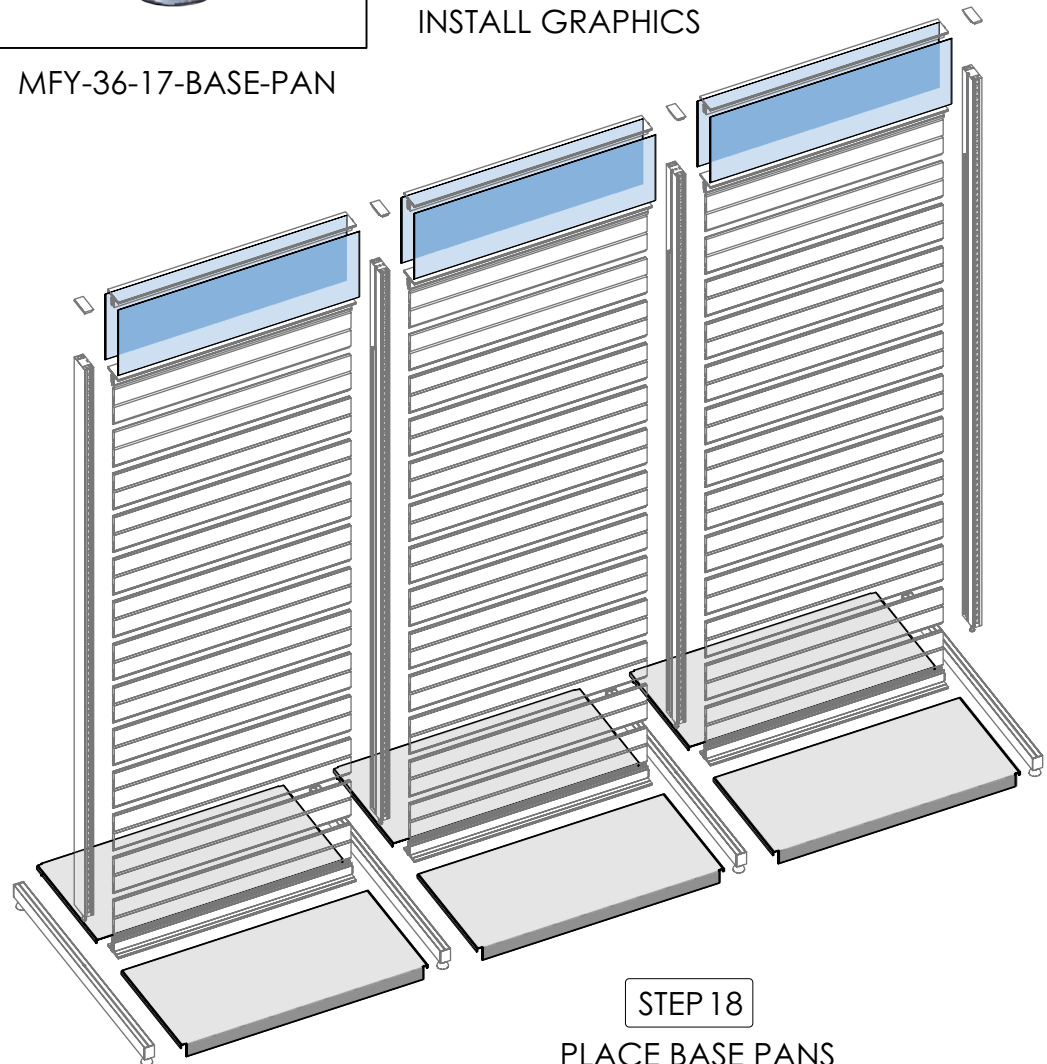

THEN PRESS ALONG THE PERIMETER EDGE

















STEP 18  
PLACE BASE PANS  
IN GROOVE(FOOT)







# SETUP INSTRUCTIONS

QTY	IMAGE	DESCRIPTION
6		36in WIDE X 17.25in DEEP - DROP-IN BASE PAN
6		(39.26 w X 15.07 h total size ) 35.26 w X 11.07 h finish size, Dye-sub print on Eclipse Blockout Stretch, single sided, sewn with FCE-2 silicone beading around perimeter & pull tab in bottom right corner (WITH 1/4" NOTCH LEFT & RIGHT BOTTOM HORIZONTAL SIDE CORNERS)

# Kit Hardware BOM

ITEM	COMPONENTS	QTY	DESCRIPTION
	004-883	6	883MM (34.76in) OF SWC EXTRUSION
	004-1973	6	1973MM (77.68in) OF SWC EXTRUSION
	005-879	39	879MM (34.61in) LENGTH OF SLOTWALL EXTRUSION
	824-947	1	947MM (37.28IN) LEFT SUPPORT LEG
	824-947	2	947MM (37.28IN) MIDDLE SUPPORT LEG
	824-947	1	947MM (37.28IN) RIGHT SUPPORT LEG
	832-2350	2	2350MM (92.52in) MIDDLE UPRIGHT
	832-EC	2	7MM SEG PLASTIC END CAP FOR 832 EXTRUSION
	833-2350	1	2350MM (92.52in) LEFT UPRIGHT
	833-2350	1	2350MM (92.52in) OF 833 DOUBLE SIDED UPRIGHT CLOSED EXTRUSION
	833-EC	2	7MM SEG PLASTIC END CAP FOR 833 EXTRUSION
	835-883-01-01	9	883MM (34.76in) OF SINGLE SIDED SEG EXTRUSION -WITH CAM LOCKS BOTH ENDS
	MFY-BOLT-375-16-2.5	4	3/8-16 x 2.5"L bolt
	MFY-DB-36-17	6	36in WIDE X 17.25in DEEP - DROP-IN BASE PAN

# Kit Graphics BOM

	MFY-DS-04-A-G	1	(39.26 w X 15.07 h total size ) 35.26 w X 11.07 h finish size, Dye-sub print on Eclipse Blockout Stretch, single sided, sewn with FCE-2 silicone beading around perimeter & pull tab in bottom right corner (WITH 1/4" NOTCH LEFT & RIGHT BOTTOM HORIZONTAL SIDE CORNERS)
	MFY-DS-04-B-G	1	(39.26 w X 15.07 h total size ) 35.26 w X 11.07 h finish size, Dye-sub print on Eclipse Blockout Stretch, single sided, sewn with FCE-2 silicone beading around perimeter & pull tab in bottom right corner (WITH 1/4" NOTCH LEFT & RIGHT BOTTOM HORIZONTAL SIDE CORNERS)
	MFY-DS-04-C-G	1	(39.26 w X 15.07 h total size ) 35.26 w X 11.07 h finish size, Dye-sub print on Eclipse Blockout Stretch, single sided, sewn with FCE-2 silicone beading around perimeter & pull tab in bottom right corner (WITH 1/4" NOTCH LEFT & RIGHT BOTTOM HORIZONTAL SIDE CORNERS)
	MFY-DS-04-D-G	1	(39.26 w X 15.07 h total size ) 35.26 w X 11.07 h finish size, Dye-sub print on Eclipse Blockout Stretch, single sided, sewn with FCE-2 silicone beading around perimeter & pull tab in bottom right corner (WITH 1/4" NOTCH LEFT & RIGHT BOTTOM HORIZONTAL SIDE CORNERS)
	MFY-DS-04-E-G	1	(39.26 w X 15.07 h total size ) 35.26 w X 11.07 h finish size, Dye-sub print on Eclipse Blockout Stretch, single sided, sewn with FCE-2 silicone beading around perimeter & pull tab in bottom right corner (WITH 1/4" NOTCH LEFT & RIGHT BOTTOM HORIZONTAL SIDE CORNERS)
	MFY-DS-04-F-G	1	(39.26 w X 15.07 h total size ) 35.26 w X 11.07 h finish size, Dye-sub print on Eclipse Blockout Stretch, single sided, sewn with FCE-2 silicone beading around perimeter & pull tab in bottom right corner (WITH 1/4" NOTCH LEFT & RIGHT BOTTOM HORIZONTAL SIDE CORNERS)