

Formulate Master 3D Hanging Structures: 4-Sided Pin Wheel

4PIN

Formulate® tension fabric hanging structures are made in the USA and are of the utmost quality and durability. Formulate combines state-of-the-art zipper pillowcase dye-sublimated stretch fabric coverings with advanced, lightweight aluminum structures to provide unique design, functionality, and style.



features and benefits:

- Structures come in varying heights of 2', 3', 4', 5' & 6'
- Shapes 10' wide and under are constructed with 30mm (1 1/8") tubes and push button connectors for simple assembly
- Shapes 12' and over are constructed with 50mm (2") tubes and internal expanding spigot connectors for unmatched structural integrity
- Premium aluminum tube frames with snap button assembly
- Easy to store and ship
- Quick to set up
- Four zipper pillowcase fabric graphics
- Lifetime limited hardware warranty against manufacturer defects

dimensions:

Hardware

Assembled unit:

(8', 10', 12', 14', 16', 18' or 20')w x (2', 3', 4', 5', or 6')h

(2.44, 3.05, 3.66, 4.27, 4.88, 5.49, or 6.1)m(w) x (.61, .91, 1.22, 1.52, or 1.83)m(h)

Approximate weight with cases:

Depending on size, weight varies between:

44lbs/19.9kgs - 264lbs/119.8kgs

Shipping

Graphic

Packing case(s):

1-4 expandable cardboard boxes depending on size

Shipping dimensions:

Expandable cardboard box length (l) may vary

45-98"l x 16"w x 16"h

1143-2489.2mm(l) x 406.4mm(w) x 406.4mm(h)

Approximate total shipping weight

(includes cases & graphics):

Depending on size, weight varies between:

54lbs/24.6kgs - 329lbs/149.2kgs

Graphic dimensions can be found in the graphic templates.

For more information visit:

www.Exhibitors-handbook.com/graphic-templates

additional information:

Graphic material:

dye-sublimation zipper pillowcase fabric

We are continually improving and modifying our product range and reserve the right to vary the specifications without prior notice. All dimensions and weights quoted are approximate and we accept no responsibility for variance. E&OE. See Graphic Templates for graphic bleed specifications.

Included In Your Kit

Tools, Components & Connectors



ES50-2W x8



EYEBOLT x4



ES50-C-ES50-S-ASY x8



ES50 x16

Tubes



4PIN-14-T1 x16



4PIN-14-T2 x4



4PIN-14-T2-M x4



SPDR-30-S2-2 x8



SPDR-50-S5-02 x8

Graphics

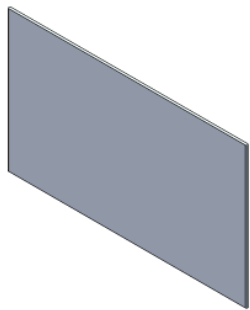

4PIN-1402-G x4

Exploded View

4PIN-1402

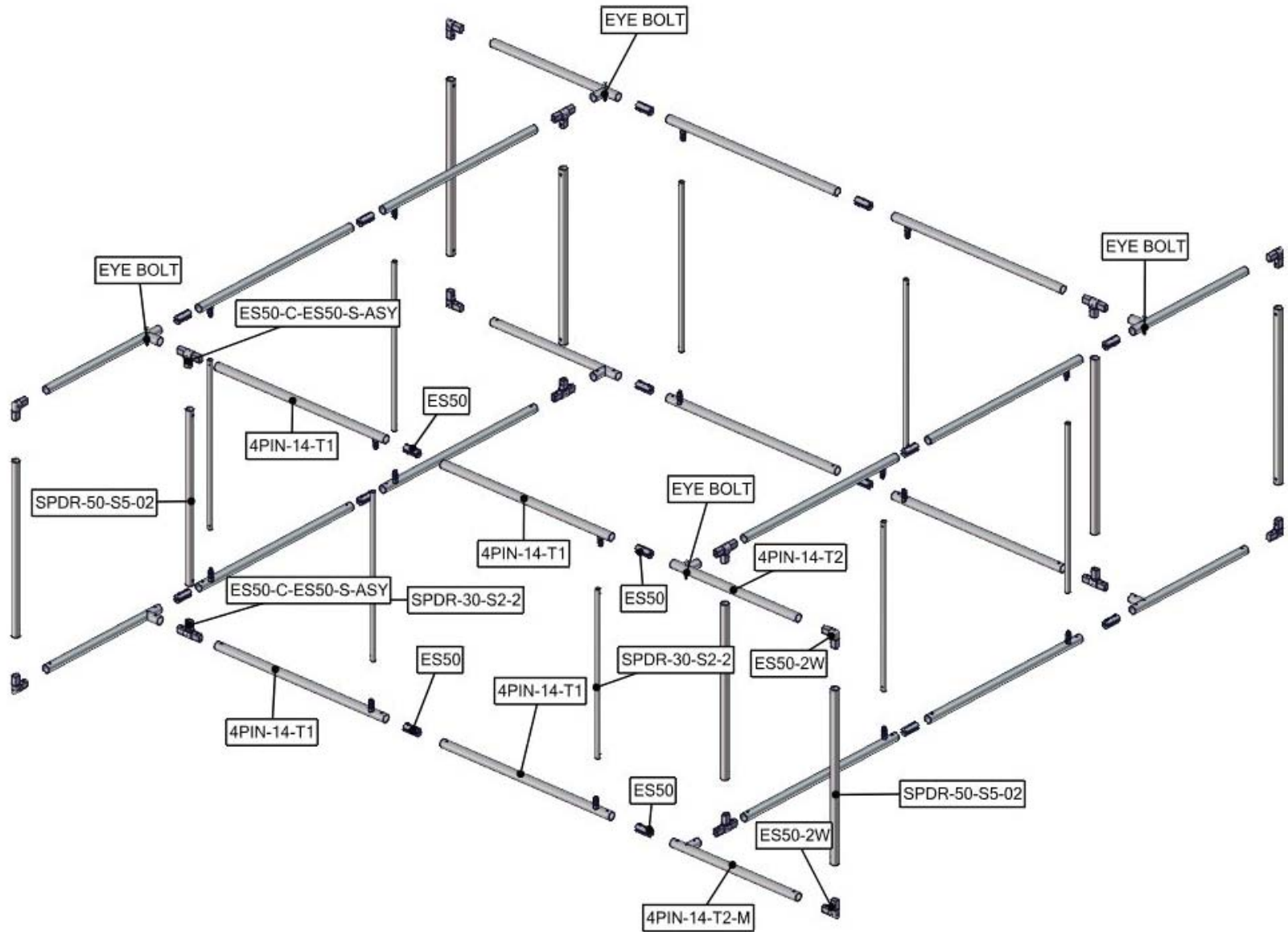

Connection Methods

Formulate™ structures use a number of different yet simple connection methods. Your kit will include one or more of the connection methods shown below. Steps within the Kit Assembly will reference a specific method for each connection point.

Connection Method 1: ES30 / ES50 / ES75

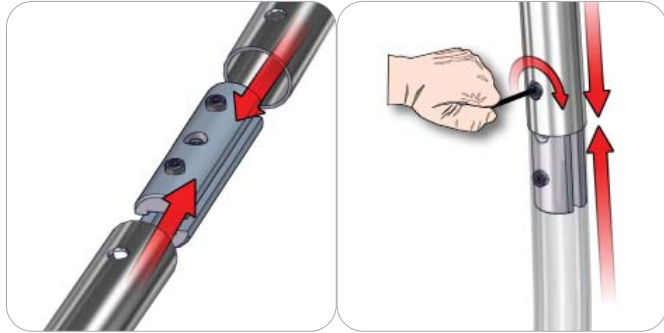

Compress the unlocked connector and slide one tube onto each end. Lock both screws carefully using your allen key tool. Be sure to lock securely, but do not overtighten.

Connection Method 2: Snap Buttons & Swage

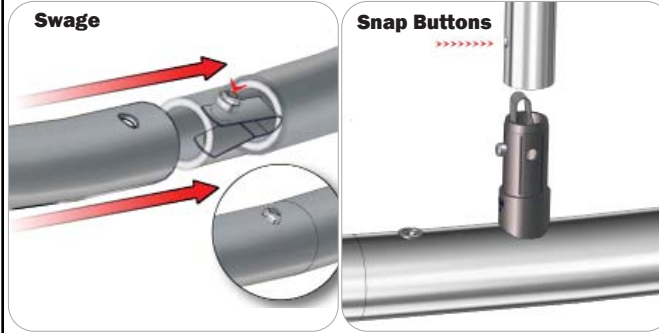

Locate the snap button on the connector or swage tube. Locate the hole on the corresponding tube. Press the snap button with your thumb and slide the tube and connector together so that the snap button snaps fully into the lock hole. To disassemble, press the snap button and pull apart.

Connection Method 3: ES30-90B / ES30-I / ES30-C

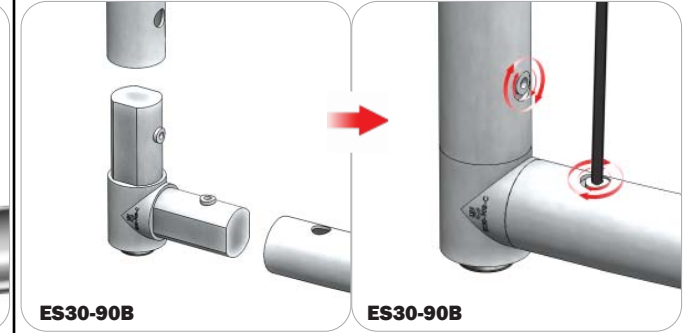

Compress one unlocked end of the connector and slide it through one tube end. Compress the other end of the connector and slide the second tube on. Lock both screws carefully using your allen key tool. Be sure to lock securely, but do not overtighten.

Connection Method 4: Tube Clamps

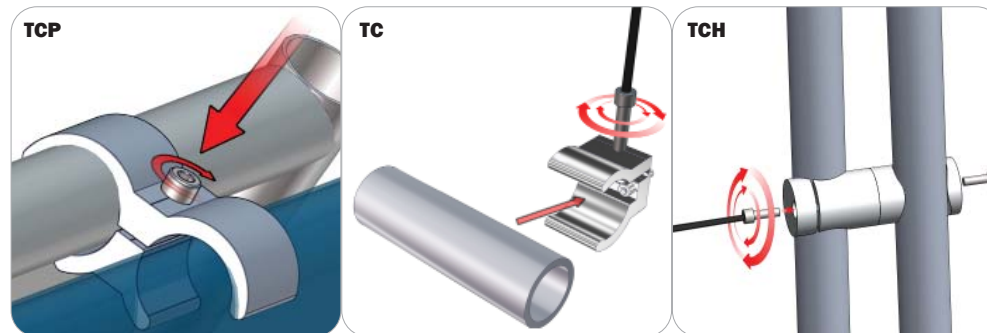

Be sure to fully assemble all frames before using clamps. With the clamp unlocked, place one tube of the first frame into the mouth of the clamp. Place the second tube (if applicable) into the second mouth of the clamp. With both frame's tubes in the clamp, be sure to lock securely, but do not overtighten.

Kit Assembly

Step by Step:

Step 1.

Locate the components necessary for assembling the frames referenced in the exploded view page.

Please reference Connection Methods 2 for more details.

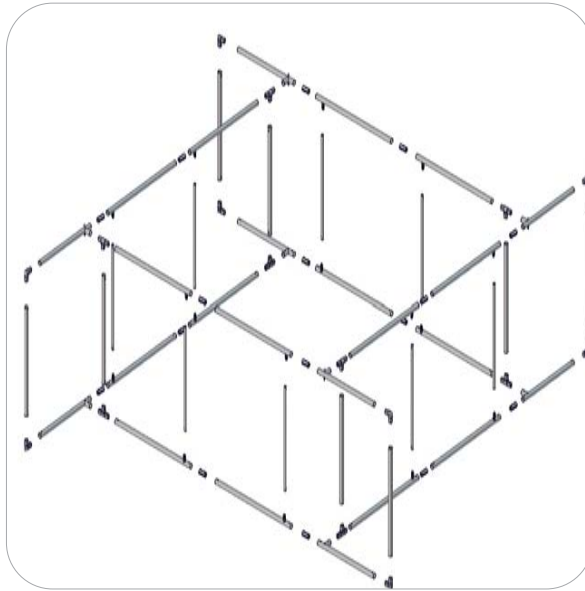
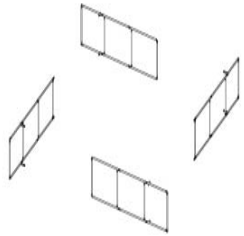

Step 2.

Apply the graphic pillowcases around the frame from the bottom and then zipper around the top edge.

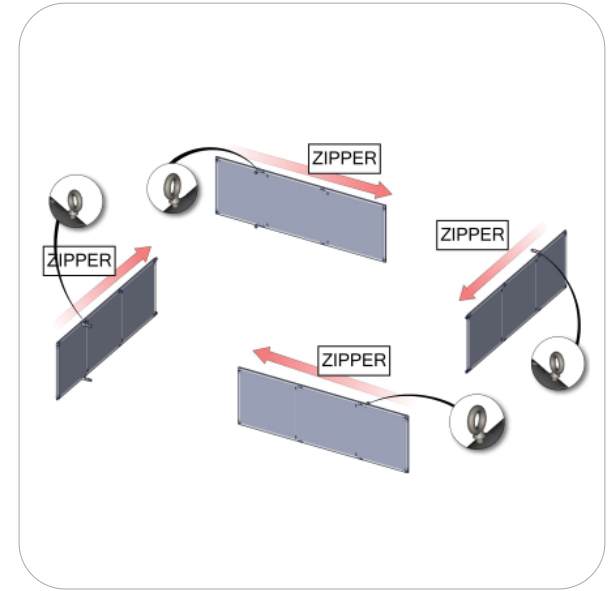
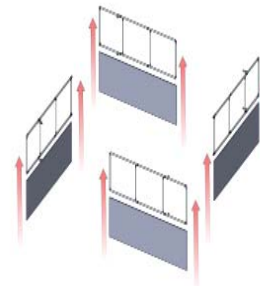

Step 3.

The structure is now ready to hang.

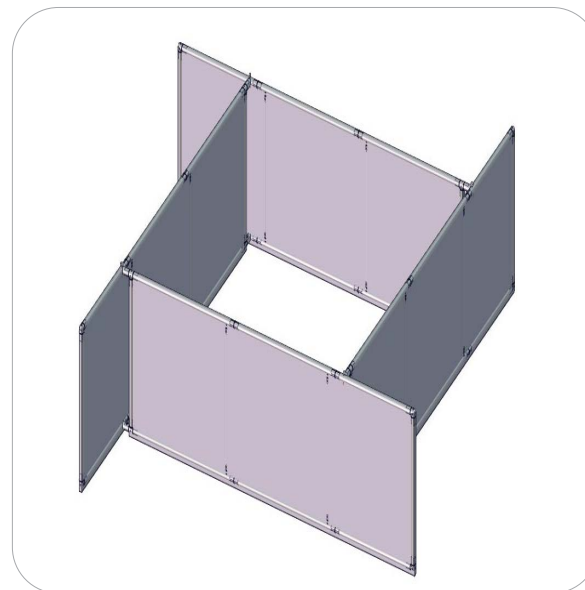

SET UP INSTRUCTIONS:

1. CONNECT BOTTOM AND TOP TUBES FOLLOWING THE LABELS
2. CONNECT SIDE TUBES
3. CLEAN THE FRAME AND PLACE THEM ON CLEAN PLACE
4. CAREFULLY REMOVE FABRIC COVER FROM BAG
5. PLACE COVER AROUND THE BOTTOM OF THE FRAME
6. PULL COVER CAREFULLY UP TO THE TOP
7. CLOSE ALL ZIPPERS
8. ADJUST FABRIC AROUND THE FRAME
9. CONNECT CABLE HARNESS TO THE EYEBOLTS
10. COMPLETELY TIGHTEN THREADED CONNECTORS

BREAK DOWN INSTRUCTIONS:

REVERSE SET-UP STEPS TO BREAKDOWN FRAME

FABRIC CARE INSTRUCTIONS:

1. UNZIP COVER ZIPPERS
2. CAREFULLY REMOVE FABRIC COVER
3. CLOSE ALL ZIPPERS
4. FOLD OR ROLL NEATLY
5. PLACE FABRIC IN COVER BAG