

IFD-H-12CC

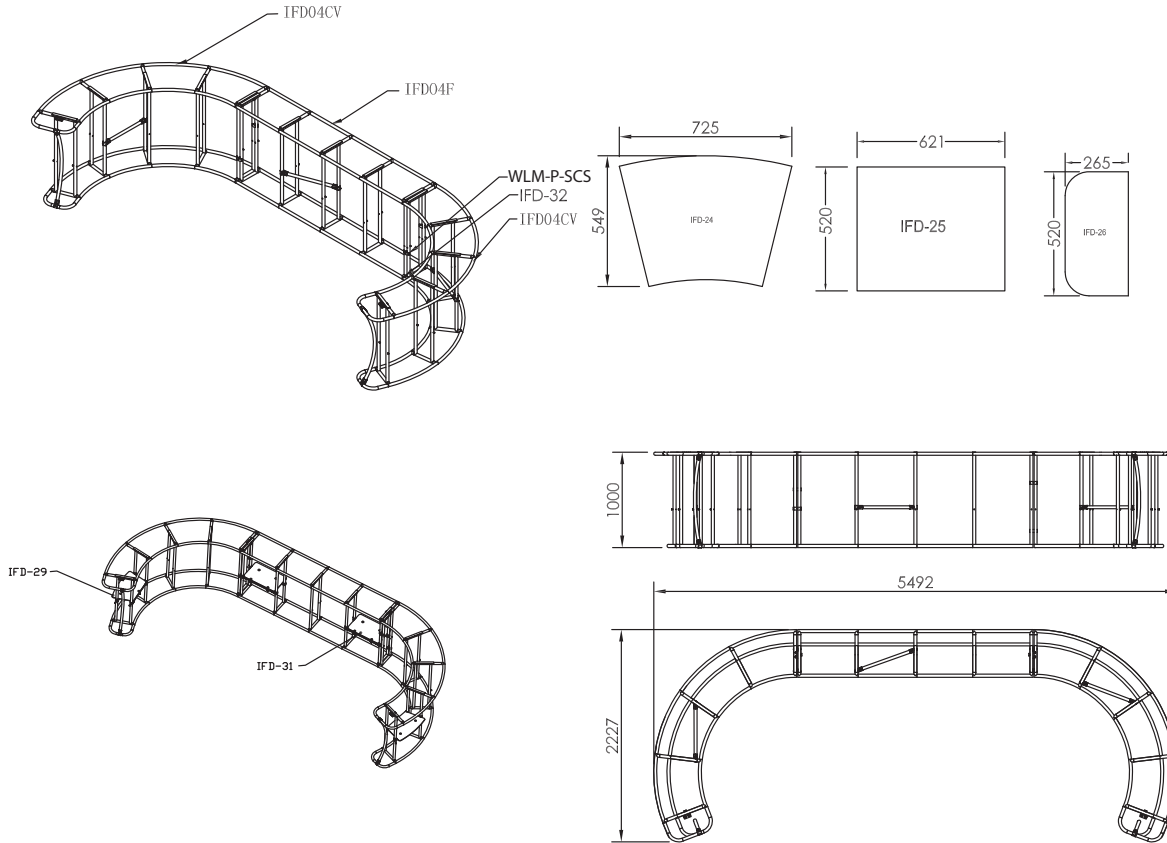

Hardware												Countertop			Graphics		Accessories			Shipping Case		
No.	Quantity	Confirm	No.	Quantity	Confirm	No.	Quantity	Confirm	No.	Quantity	Confirm	Yes / No			Single or Double-sided		IFD-29	2	CA900			
IFD04CV	2											IFD-24	8		None		IFD-31	2	CA500			
IFD04F	1											IFD-25	4		Complete				NYLON BAG			
WLM-P-SCS	4											IFD-26	2		Split-ship							
IFD-32	8																					
No.	Quantity	Confirm	No.	Quantity	Confirm	No.	Quantity	Confirm	No.	Quantity	Confirm	No.	Quantity	Confirm		Confirm	No.	Quantity	Confirm	No.	Quantity	Confirm

Set Up Instructions

IFD-H-12CC

FRAME ASSEMBLY:

Assemble base parts and poles by pressing and pushing together.

*NOT ALL PARTS WILL BE USED:

This counter is made from x3 full kits and not all parts will be needed to complete this design.

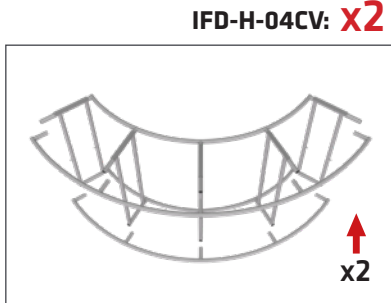
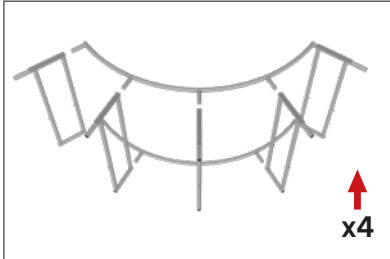
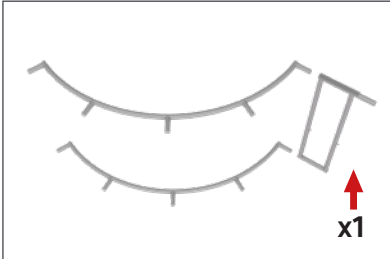
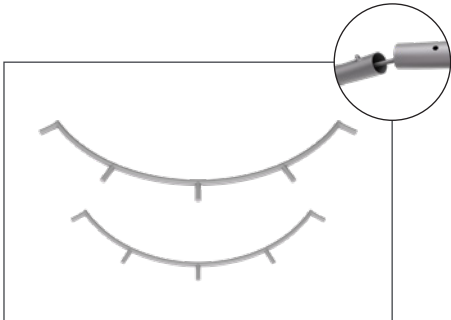

IFD-H-04CV: x2

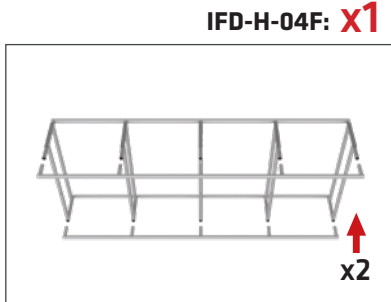
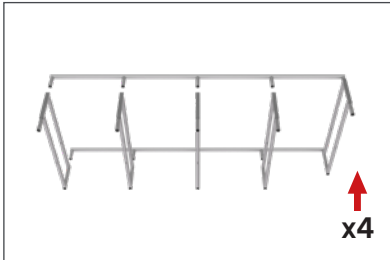
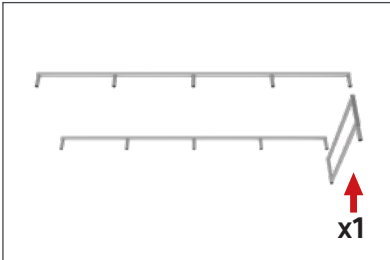
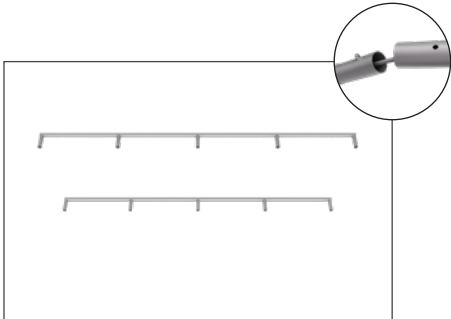

IFD-H-04F: x1

IFD-H-04CV Left

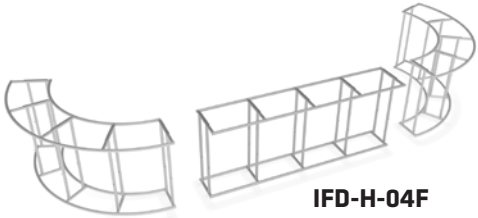

IFD-H-04F

IFD-H-04CV Right

Set Up Instructions

IFD-H-12CC

IFD-H-04CV Right:
Assemble end cap on right side only. Use hand tool when shown.

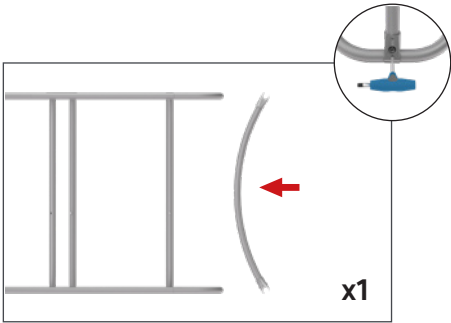
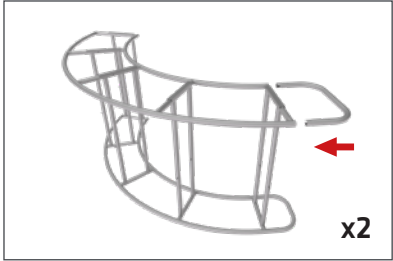

CROSSBAR SUPPORT:
Attach across second opening from the right.

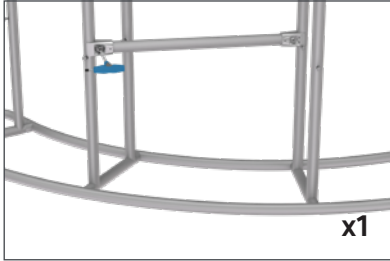

COUNTER TOP SUPPORT:
For leveling end cap counter top.



IFD-H-04CV Left:
Assemble end cap on left side only. Use hand tool when shown.

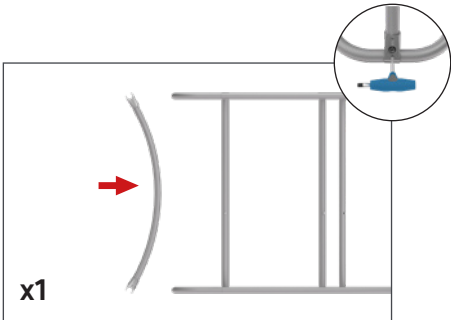
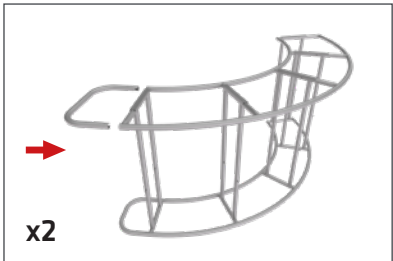

CROSSBAR SUPPORT:
Attach across second opening from the left.



COUNTER TOP SUPPORT:
For leveling end cap counter top.



IFD-H-04F:
Do not assemble end caps for IFD-H-04F center counter.

Assemble crossbar support for IFD-H-04F center counter.

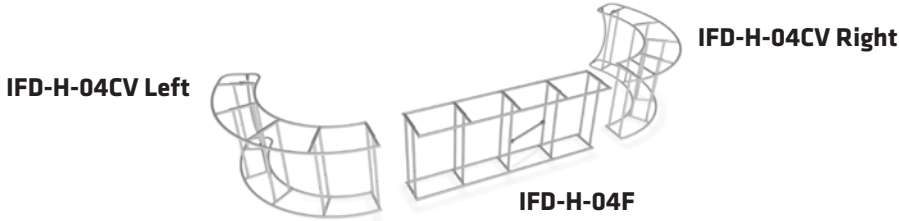

Set Up Instructions

IFD-H-12CO

CONNECT FRAMES TOGETHER:
Connect x3 frames together with x2 butterfly clips (WLM-P-SCS) per

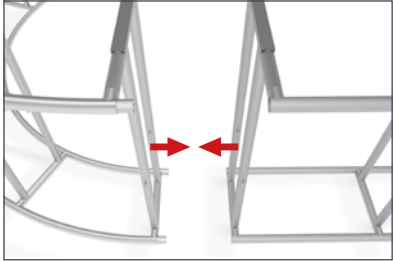

frame connection. Attach one clip to outside of frames and one clip to inside of frame using hand tool.

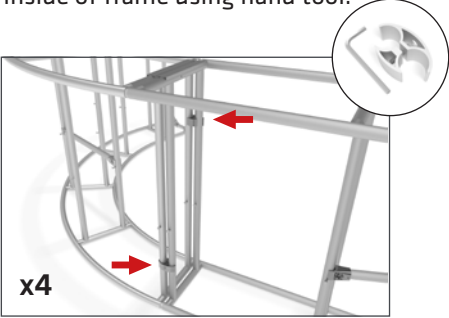

WLM-P-SCS

SHELVES:
(OPTIONAL) To add shelves to frame, position and level shelf on



frame before tightening clamps down with hex tool.

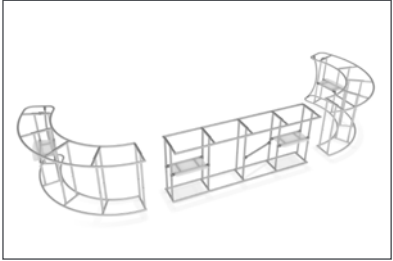

GRAPHIC INSTALL:
Step 1: Unzip print and slide print onto frame like a pillow case.

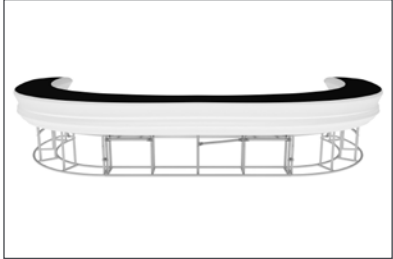

Step 2: Grip the fabric tightly and stretch around bottom of desk to pinch zipper into place. Zip the print together for taut finish.

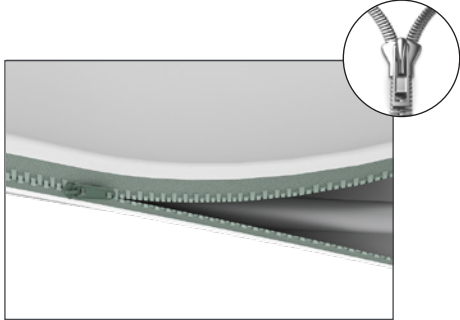

Step 3: Attach countertop panels to fabric counter with Velcro. Start at one end and work your way across to the other side.

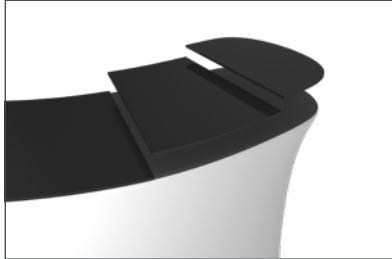

Step 4: Join counter top panels together front and back with black push-on clamps.

