

# Set Up Instructions

# WLBS-48089FS BANNER STAND

**Step 1:** Assemble straight poles by pressing and pushing together.

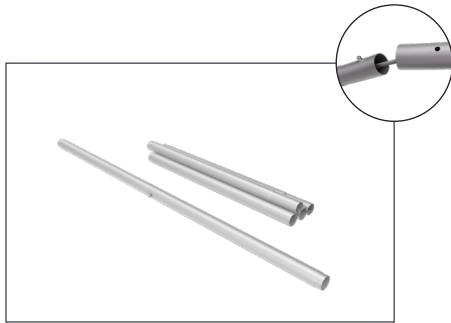

**Step 2:** Connect all corner sections to straight sections. Face holes of 90° corners towards the bottom of frame. Insert center support pole.

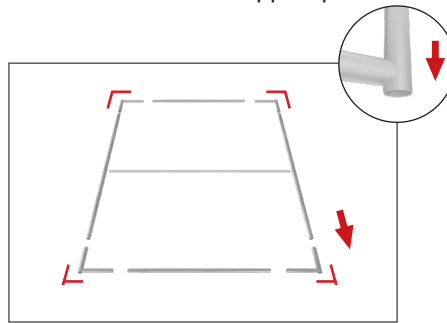

**Step 3:** Unzip print and lay image face up. Slide print onto frame like a pillow case.

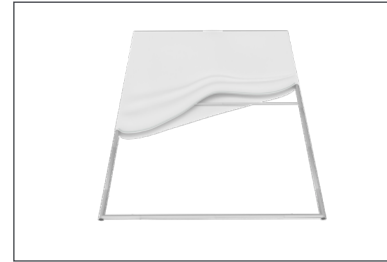

**Step 4:** Grip the fabric tightly and stretch around bottom pole to pinch zipper into place. Zip the graphic together for taut finish.

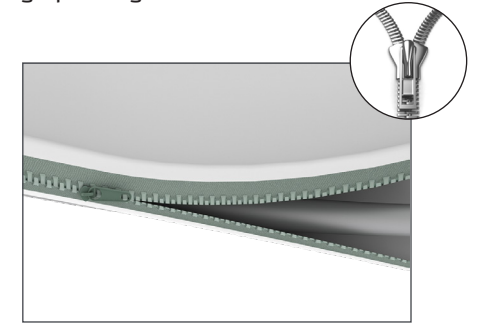

**Step 5:** Assemble post (75) into base plate or optional feet with screw by hand turning post and tightening into place.

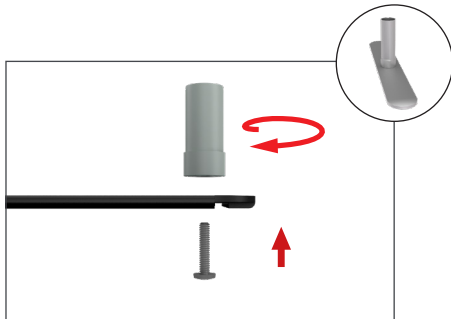

**Step 5:** Push banner stand frame onto posts of flat base or optional feet. Press evenly on both sides to make easier for the frame to go on.

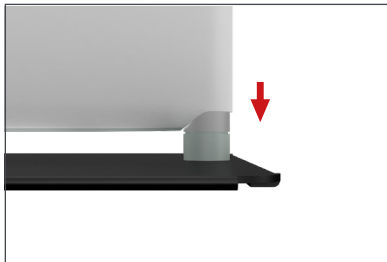

**LIGHTS:**  
(OPTIONAL) Position as desired and tighten knob to hold in place.  
**WARNING! Over tightening may cause damage to fabric image.**

