

LED Arm Light - Exhibition

LUM-LED6-ORL-B

LUM-LED6-ORL-B-EXT

Incorporate modern, bright LED light into your display and draw attention to your brand and message with elegance. With a contemporary profile, you can modernize your display, set the stage and better communicate a clear message.

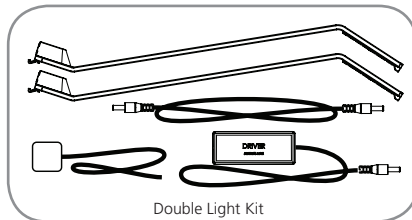
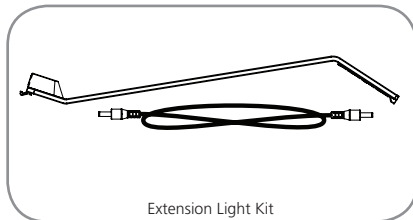
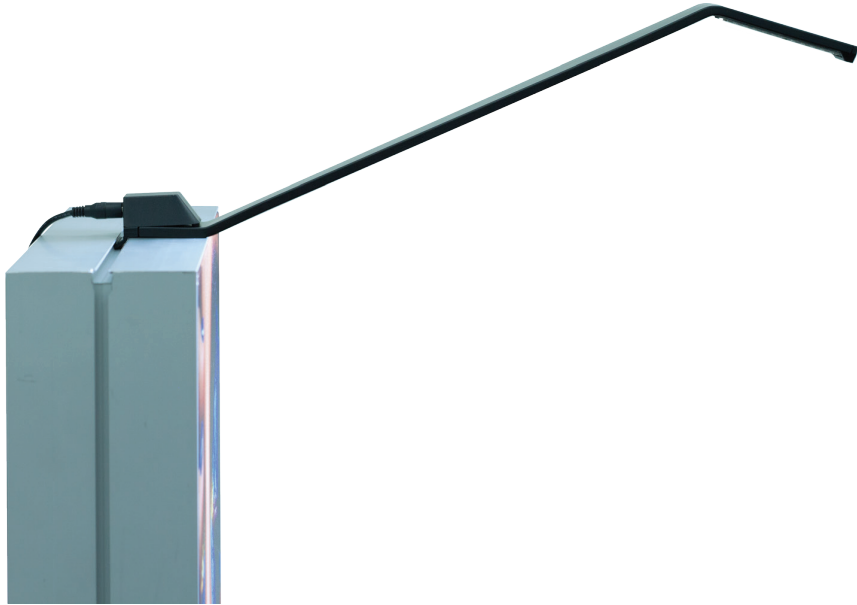

features and benefits:

- Mounts on extrusion channels
- Black coated exterior
- Projects cool white light
- Low voltage 12 watt
- Cord length is 2.5 meters from light fixture to transformer
- UL approved
- One year warranty against manufacturer defects
- Light fixture is 17.13" in length

dimensions:

Hardware

Assembled Dimensions:
Extension Kit:
1.97" w x 17.13" d
50mm(w) x 435mm(d)

Shipping

Shipping Dimensions:
Double Light Kit:
21" l x 10" h x 3" d
533mm(l) x 254mm(h) x 76mm(d)

Extension Kit:
21" l x 6" h x 3" d
533mm(l) x 152mm(h) x 76mm(d)

Approximate Shipping Weight:
Double Light Kit:
5 lbs. / 2.27 kg

Extension Kit:
2 lbs. / .91 kg

additional information:

Lighting

- 24V DC
- Lumens = 1200M
- Light temperature = 5500K

Safety Warnings

- Light is not protected against moisture. Do not expose to direct or indirect moisture.
- Overloading power supply can cause overheating, shorting and possibly fire.



WARNING
DO NOT LOOK
DIRECTLY AT LIGHT

We are continually improving and modifying our product range and reserve the right to vary the specifications without prior notice. All dimensions and weights quoted are approximate and we accept no responsibility for variance. E&OE. See Graphic Templates for graphic bleed specifications.

Connect Power Supply

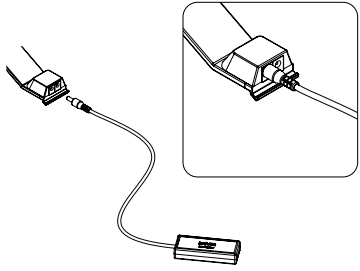

Plug the power supply into the back of the light (either socket can be used).

1

Link Lights

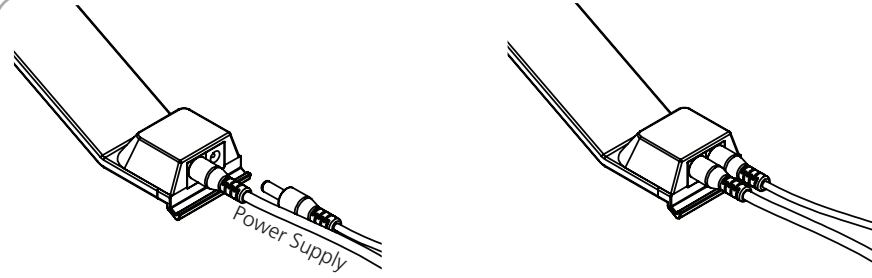

Plug the link cable into the back of the light to link lights.

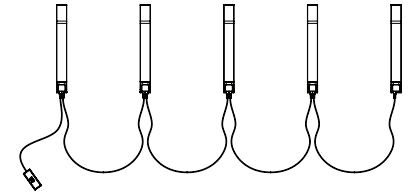

A maximum of five lights can be linked from one power supply.

1

Attach Light to Extrusion

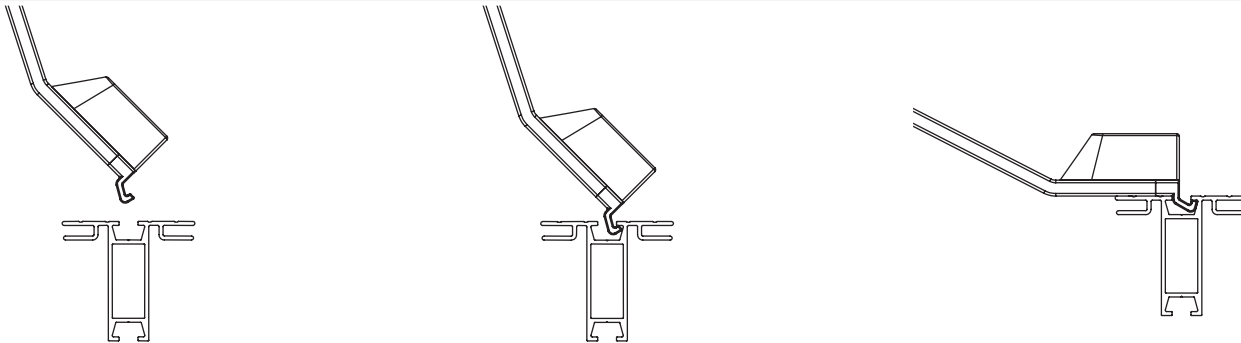

Hook light into channel profile at desired position.

1

Connect Power



Plug into the power supply there is no switch so the light will come on once plugged in.

1