

WAVELINE®

10'w x 3'h WL Hanging Sign

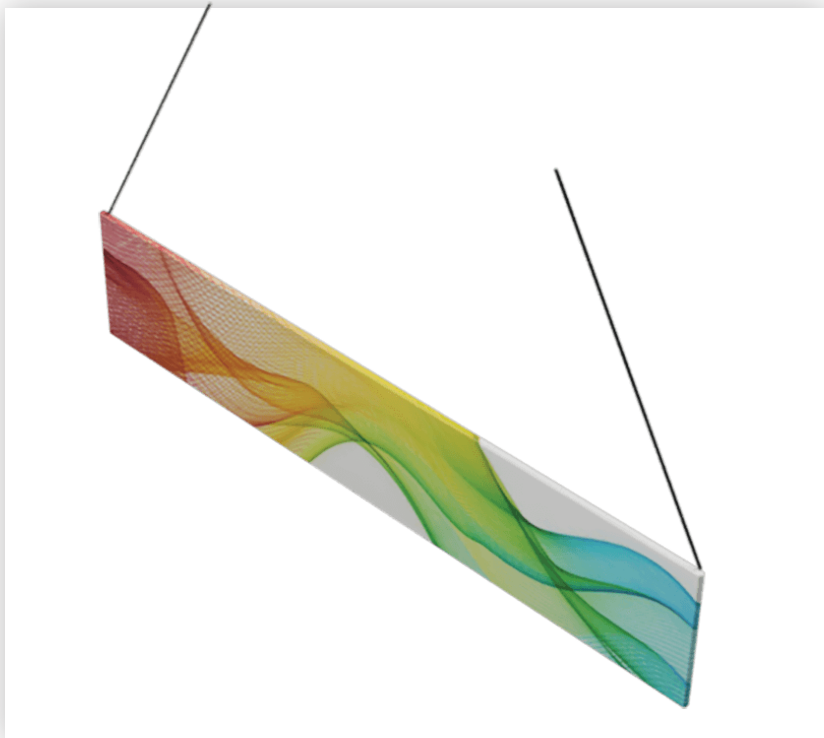
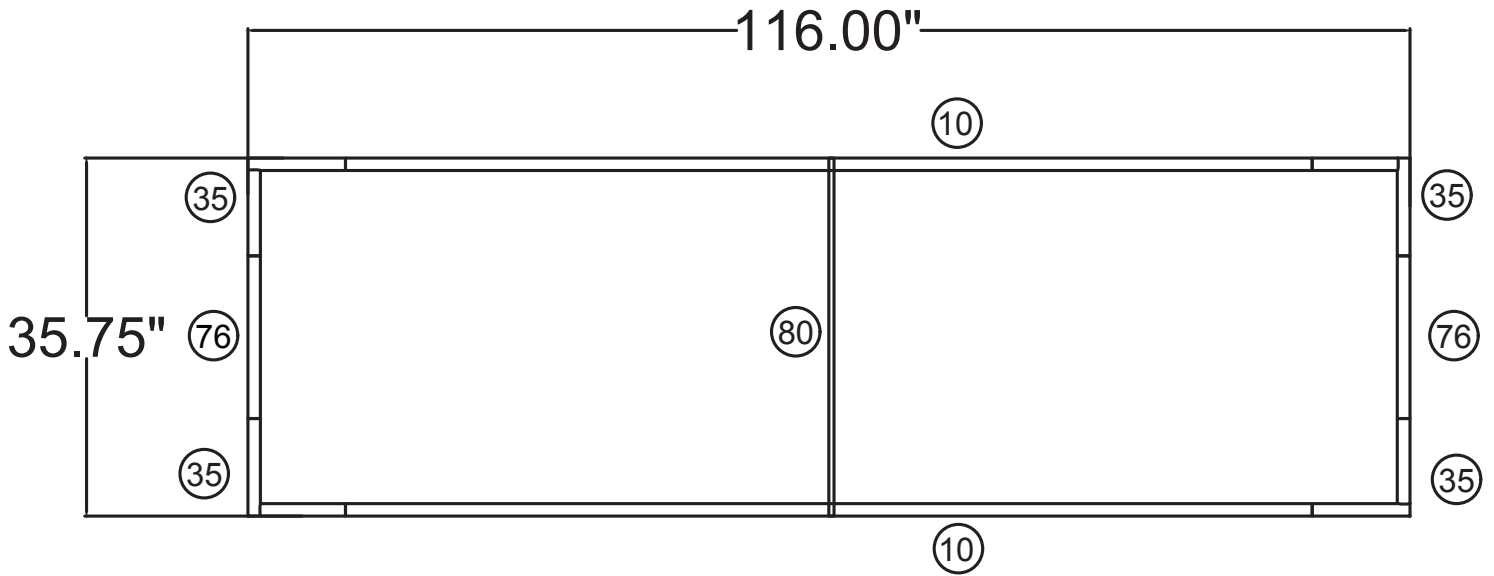

FHS1036

10'w x 3'h WL Hanging Sign	
Qty.	Part Number
4	WLM#035
2	WLM#076
1	WLM#080
2	WLM#010
1	BGO BAG-L

Notes:

- * Does not include Hanging Cables
- * will fit inside CA600 or CA900 case