

WAVELINE®

10'w x 6'h WL Hanging Sign

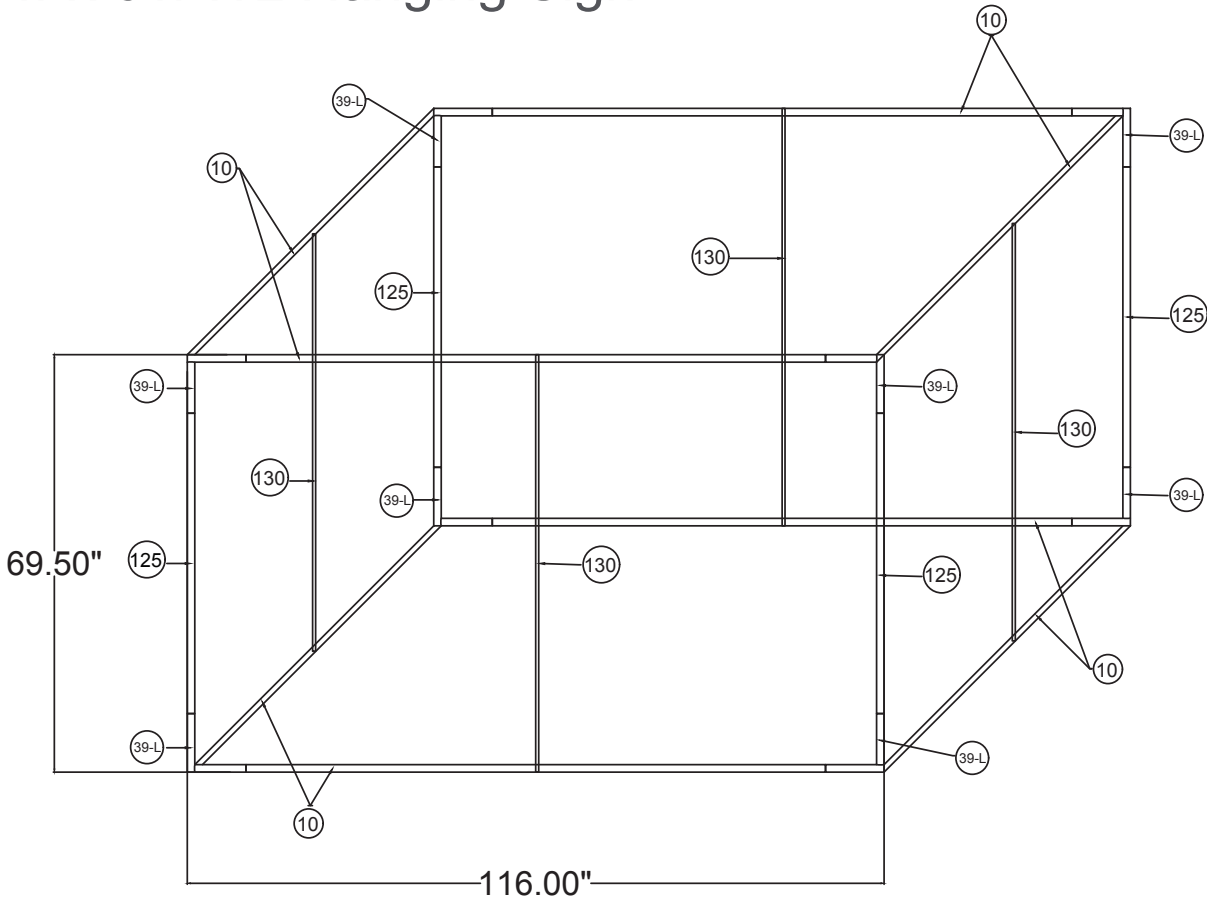

SHS1072

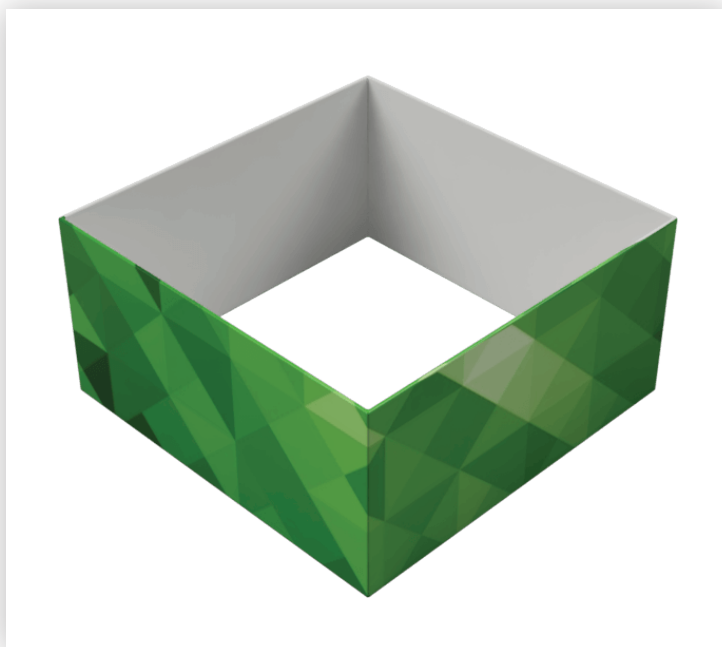

10'w x 6'h WL Hanging Sign	
Qty.	Part Number
8	WLM#039L-US
8	WLM#010
4	WLM#125
4	WLM#130
1	BGO-FABRIC-L bag

Notes:

- * Does not include Hanging Cables
- * Will fit inside a CA600 or CA900 case