

# Embrace Table

## EMB-2-TBL-BLACK

Embrace™ Table is a sleek, collapsible push-fit tension fabric return table display that delivers style with minimal effort. The Embrace table pairs a collapsible, white frame with channel bars that hold push-fit SEG fabric graphics. The kit is finished with a black thermoform counter top for a sleek appearance. The Embrace Table requires no tools for assembly, is light-weight and highly portable. It packs away as easy as it sets up!

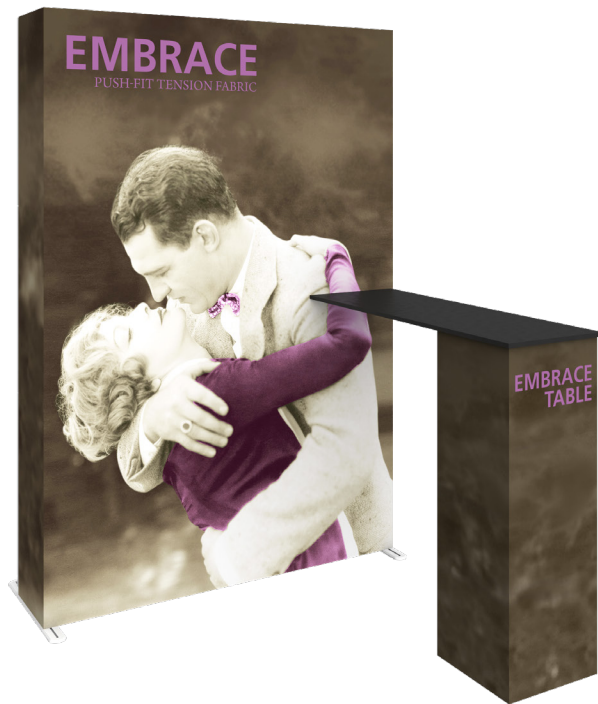

## features and benefits:

- Collapsible display return table
- Thermoform top only available in black
- Supports max 25 lbs
- Quick to set-up
- SEG dye-sublimation graphics
- Wheeled bag included
- Easy to store and ship
- Lifetime hardware warranty against manufacturer defects

## dimensions:

Hardware	Graphic
<p>Assembled Unit:</p> <p>Hardware dimensions: 14.96" w x 38.66" h x 47.25" d 380mm(w) x 982mm(h) x 1201mm(d)</p> <p>Approximate weight: 42 lbs / 20 kgs</p>	<p>Refer to related graphic template for more information.</p> <p>One year warranty</p> <p>Visit: <a href="https://www.theexhibitorshandbook.com/download-graphic-templates">https://www.theexhibitorshandbook.com/download-graphic-templates</a></p>

## Shipping

Packing Case(s):  
1 Box

Shipping Dimensions:  
49" l x 18" h x 8" d  
1245mm(l) x 458mm(h) x 204mm(d)

Approximate total shipping weight:  
45 lbs / 21 kgs

## additional information:

Graphic Material:  
Dye-sublimation SEG push-fit fabric

Table top can support max 25 lbs / 11 kgs.

When included in a larger order, a different packaging solution will be provided to accommodate all contents of the order. Individual packaging may no longer be provided.

Thermoform Tabletop Color:

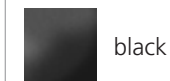

1 person assembly recommended



This product may include the following materials for recycle:  
aluminum, select wood, fabric, cardboard, paper, steel, and plastics.

We are continually improving and modifying our product range and reserve the right to vary the specifications without prior notice. All dimensions and weights quoted are approximate and we accept no responsibility for variance. E&OE. See Graphic Templates for graphic bleed specifications.

# Included In Your Kit

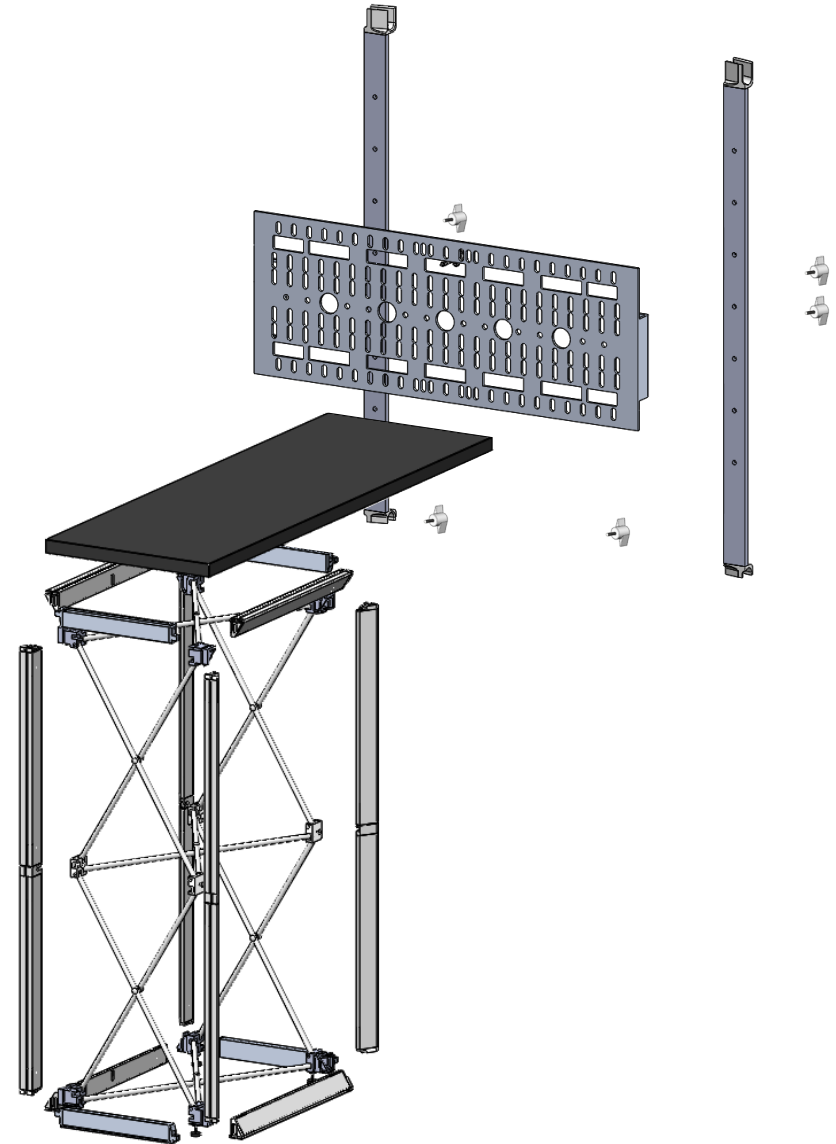
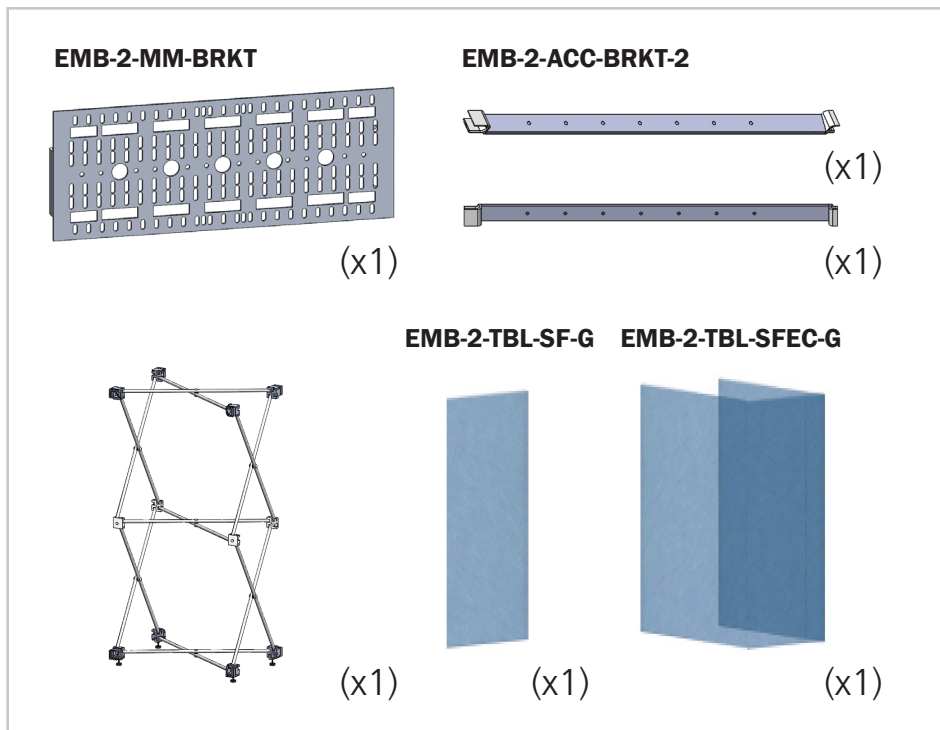
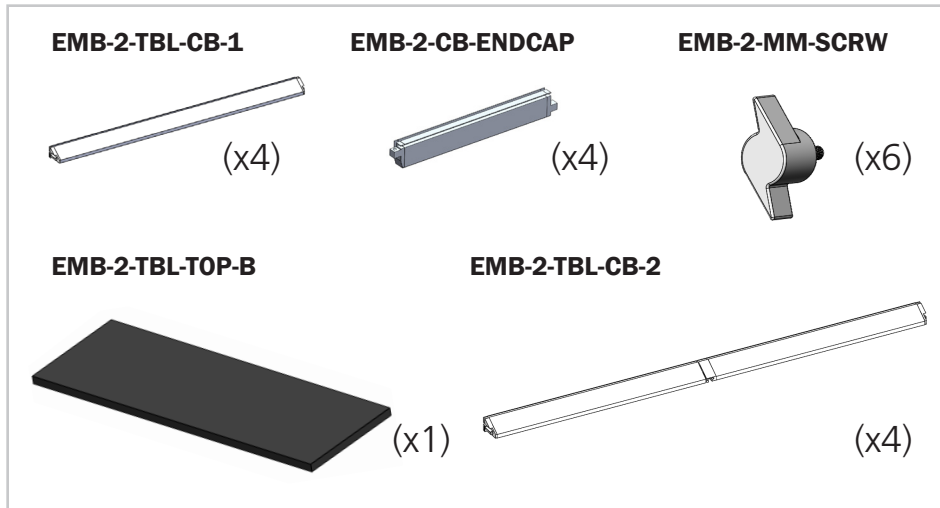

# Frame Assembly

For this step you will need:

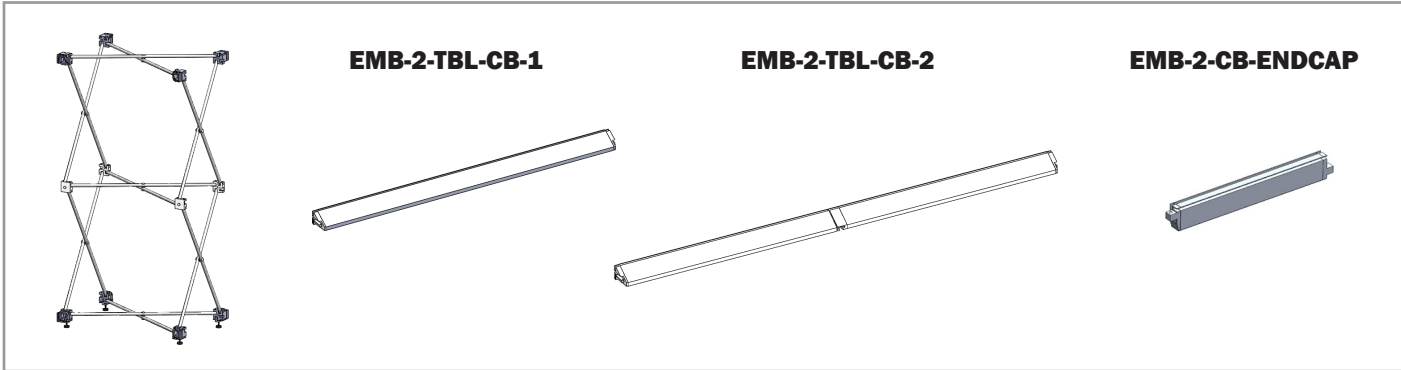

1

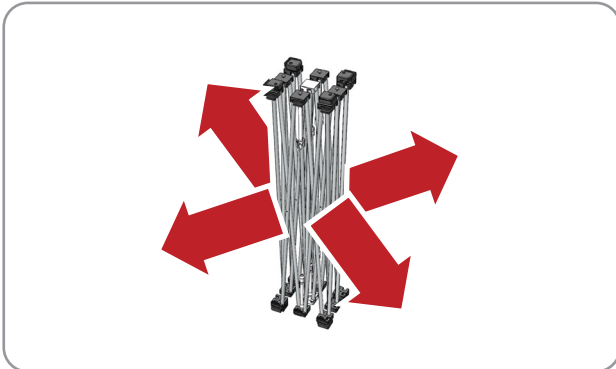

2

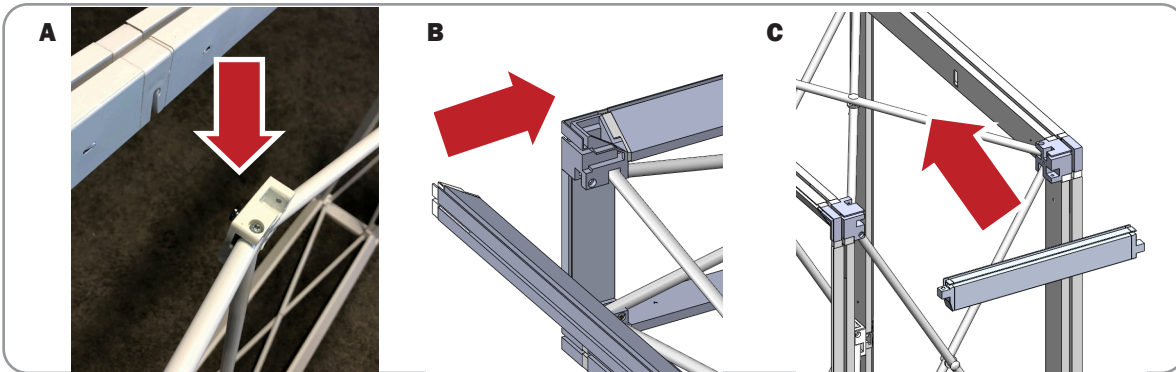

Slot the channel bars:

Put the frame off to the side.

- A. EMB-2-TBL-CB-2 on the long edges of the frame
- B. EMB-2-TBL-CB-1 on the short edges
- C. EMB-2-TBL-ENDCAP on the perpendicular edges

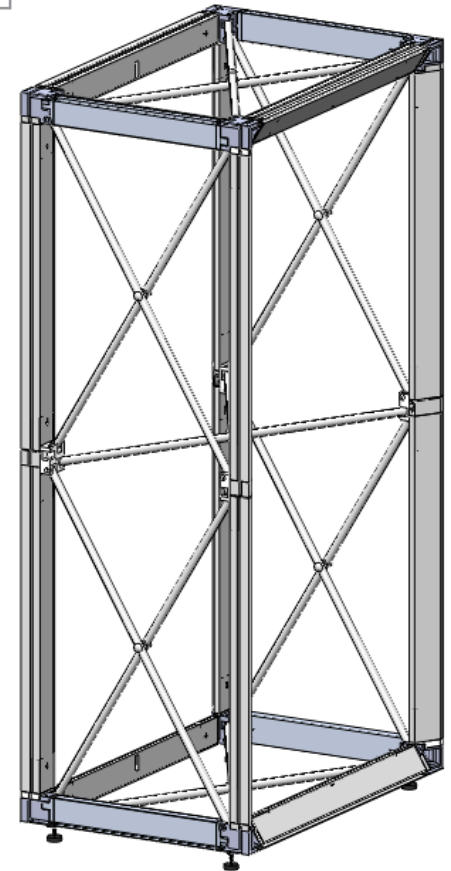

# Monitor Mount Assembly Step 1

For this step you will need:

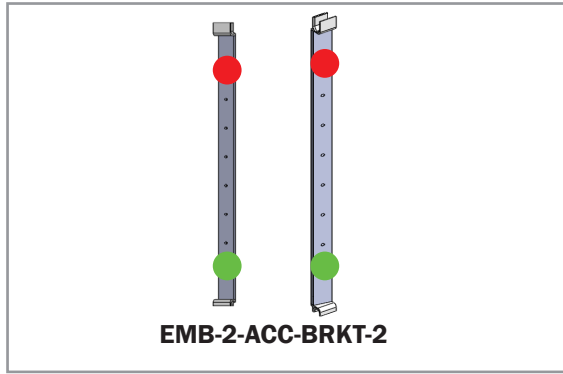

1. Locate the stickers on the Embrace monitor mount accessory brackets and adjust them so that they are rotated to the correct orientation.

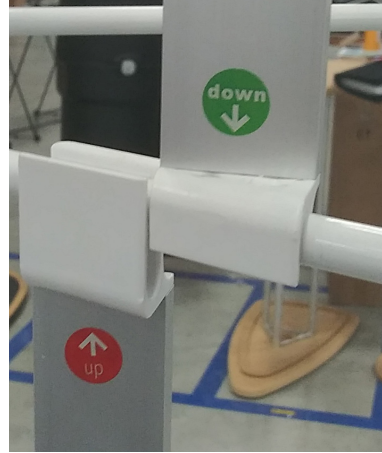

Need red to be facing upward

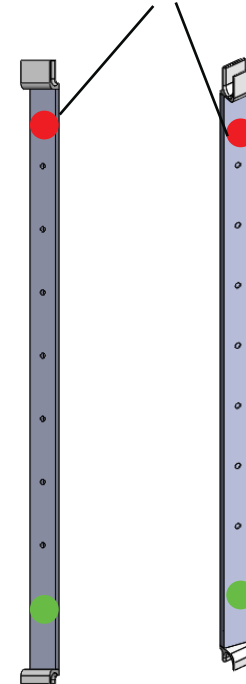

2. Using the stickers as a guide, align the accessory brackets and monitor bracket to their proper location before assembling.

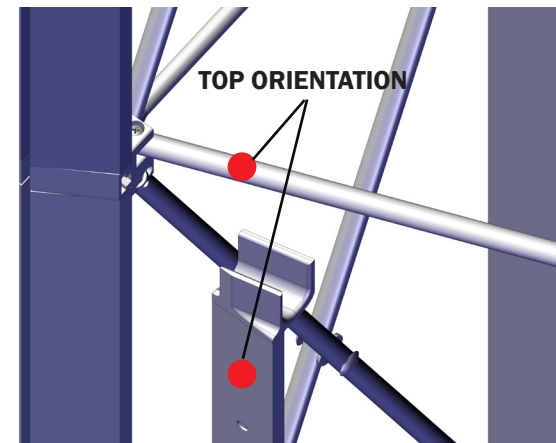
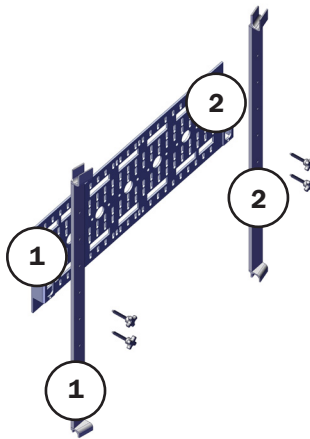

# Monitor Mount Assembly Step 2

For this step you will need:

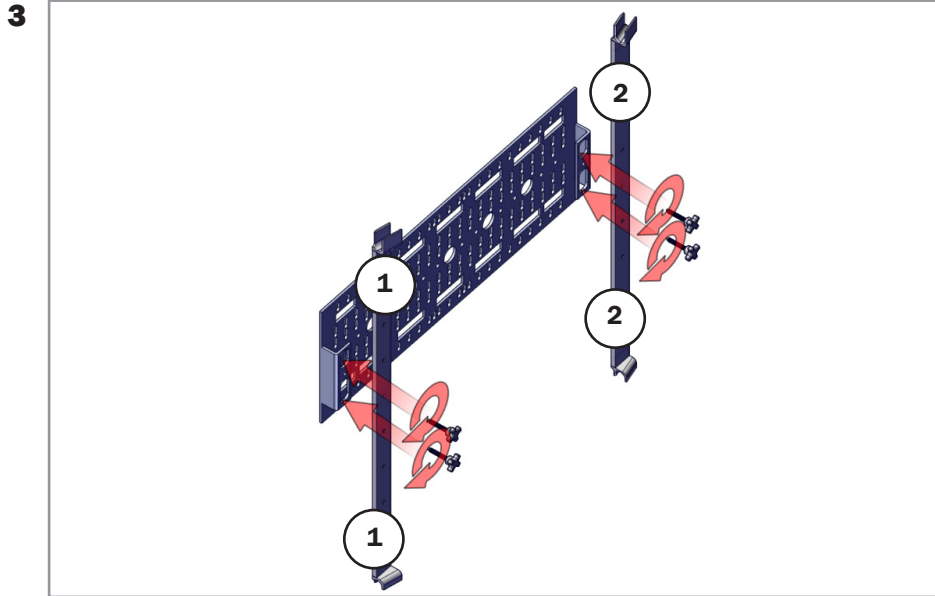
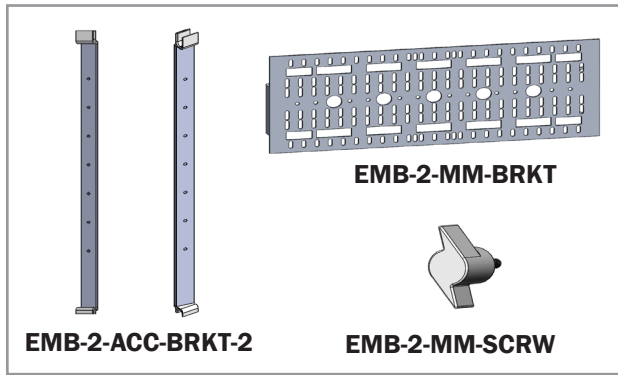

Assemble the Embrace monitor mount by attaching the monitor bracket to the accessory brackets using the included screws. Use the color stickers and number labels to help you assemble and know proper orientation of parts.

REAR VIEW

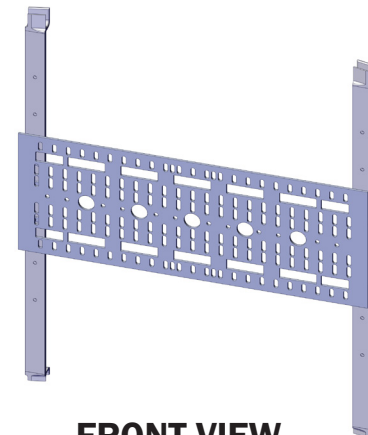
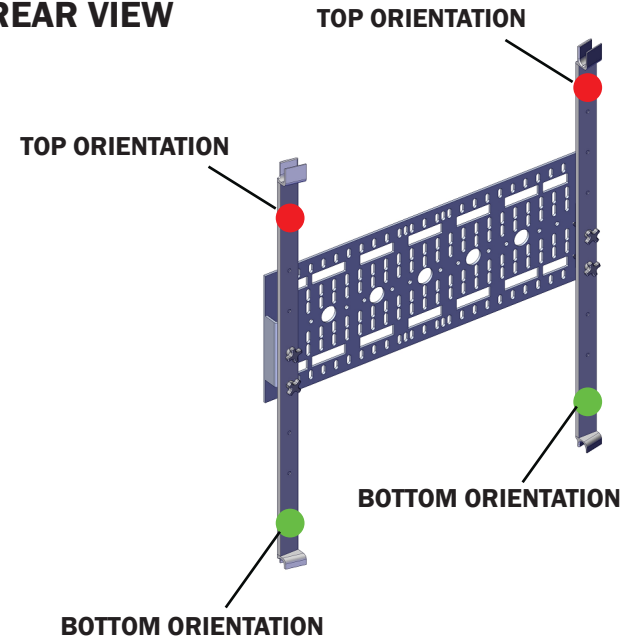

FRONT VIEW  
COMPLETE SETUP

# Monitor Mount Assembly Step 3

For this step you will need:

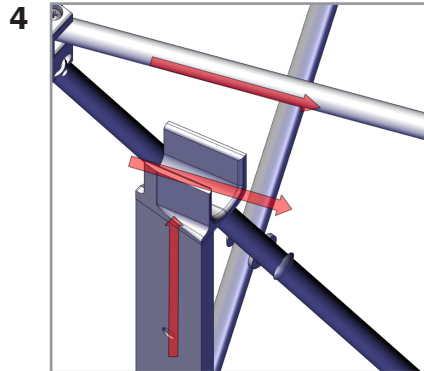
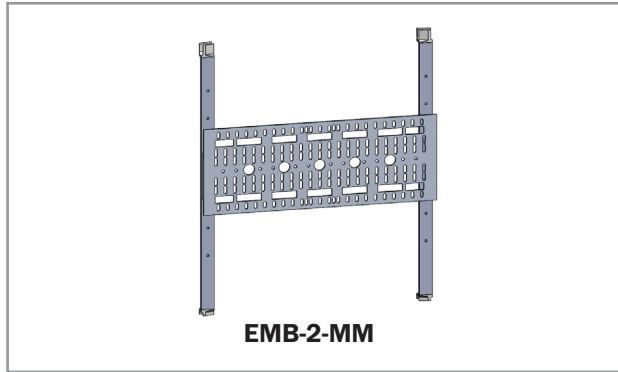

Assemble the monitor mount to the Embrace frame by first tilting it up and pushing the top of the accessory brackets to the upper Embrace scissors.

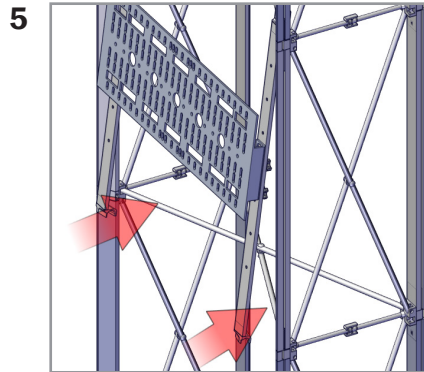

Finish the assembly by attaching the bottom of the accessory brackets to the Embrace scissors. You may need to push the brackets up to fit them in place.

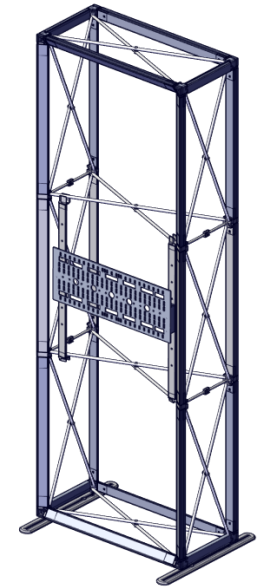
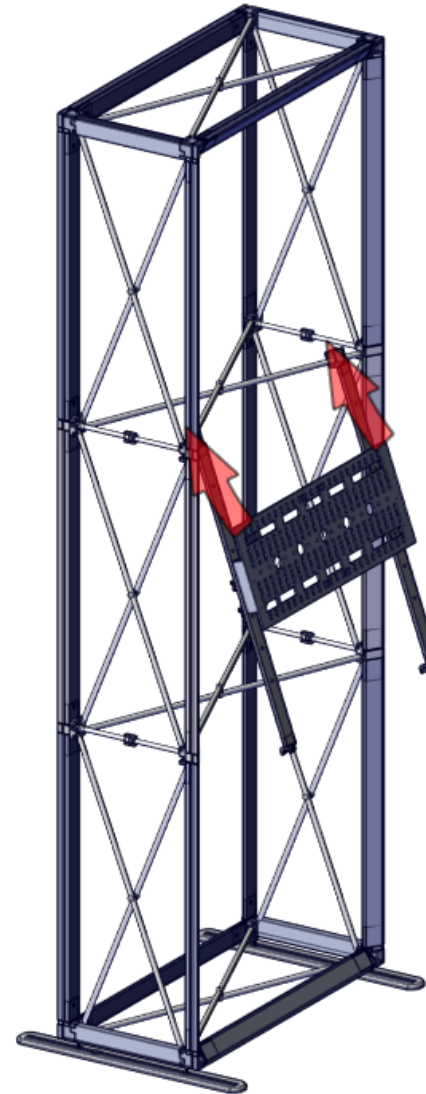

COMPLETE SETUP



# Graphic Application

For this step you will need:

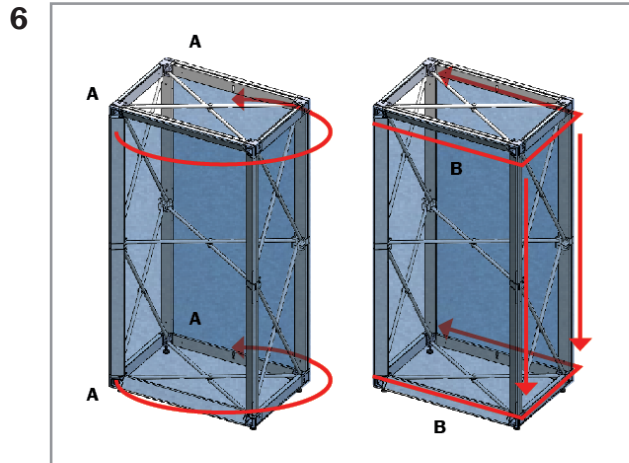
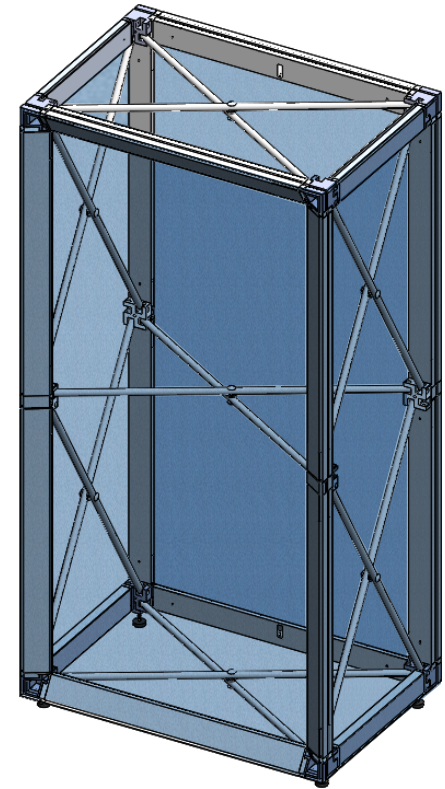
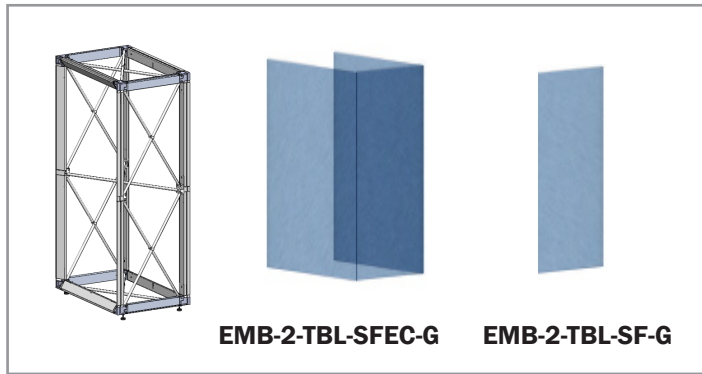

A. Apply the front graphic to the frame by fitting the top and bottom corners of a single side first, wrapping the graphic around to the opposite side, and fitting the top and bottom corners.

B. Press the graphic into the graphic channels on the sides and front.

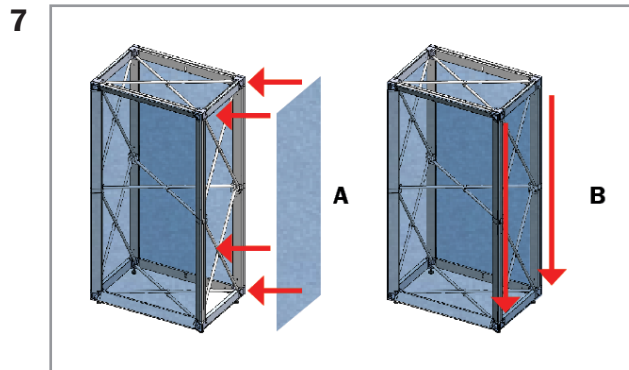
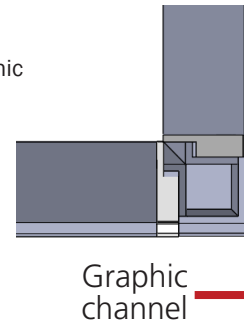

A. Apply the back graphic to the frame by fitting the graphic into the four corners first.

B. Press the graphic into the graphic channel.

Note: part of the frame will be exposed after both graphics have been applied.

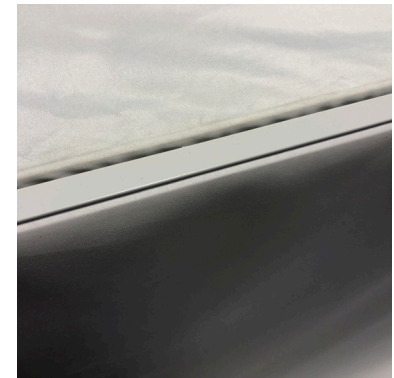

# Table Assembly

For this step you will need:

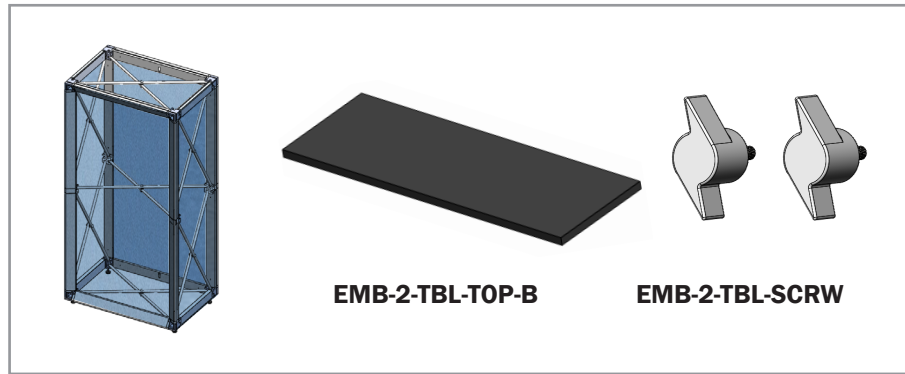

8

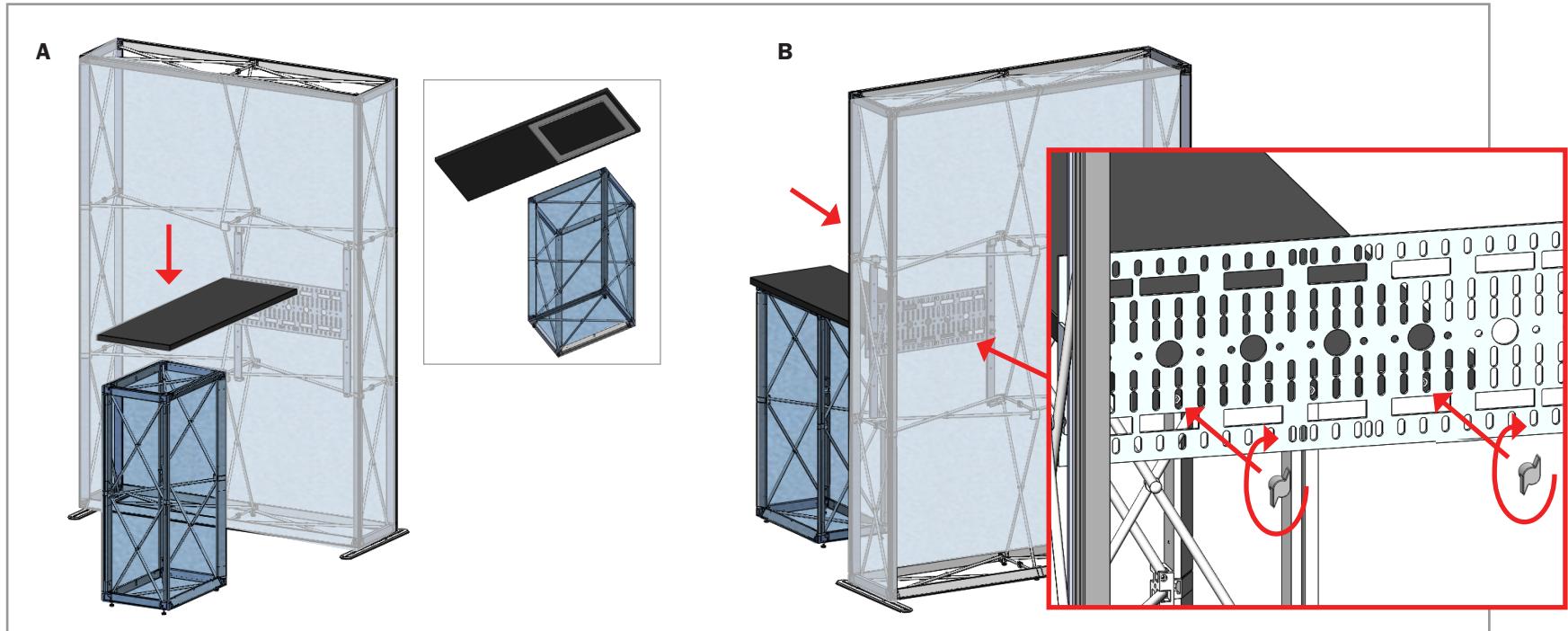

A. After applying the backwall graphic, lower the table onto the frame so the frame rests in the route.

B. Complete installation by pushing the table assembly against the monitor mount and attaching with the included screws. Screws will go through the bracket and pre-cut holes in the graphic, then into the inserts of the table top.