

Formulate 10' Vertical Curve - Kit 9

FMLT-WV10-09

Formulate™ is a collection of sophisticated, ergonomically designed exhibit booths. Formulate combines state-of-the-art zipper pillowcase dye-sublimated fabric coverings with advanced lightweight aluminum structures to provide unique design, functionality, and style. The excellence of the Formulate line of displays, hanging structures and products is simply unmatched. Stretch fabric graphics are hand-sewn, durable and dry-cleanable.



We are continually improving and modifying our product range and reserve the right to vary the specifications without prior notice. All dimensions and weights quoted are approximate and we accept no responsibility for variance. E&OE. See Graphic Templates for graphic bleed specifications.

features and benefits:

- State-of-the-art 30mm aluminum tube frame with snap button assembly
- Easy to store and ship
- Quick to set up
- Table holds max 10 lbs / 4.5 kg
- Kit includes: one frame, one dye-sublimated pillowcase zipper graphic, stand-off monitor mount, side table, and one wheeled OCH2 and OCL storage case
- Lifetime hardware warranty against manufacturer defects

dimensions:

Hardware

Assembled unit:
114" w x 92.8" h x 45.2" d

Stand-off monitor mount (with table):
36.3" w x 92.7" h x 28.8" d
Table dimensions: 20.5" w x 11.8" d
Monitor mount: Max T.V. size is 37", 40 lbs.

Approximate weight (includes graphic):
58.63 lbs / 26.6 kgs

Shipping

Shipping dimensions:
One OCL case: 56" l x 19" h x 19" d
One OCH2 case: 52" l x 29" h x 15" d

Approximate shipping weight (with case):
108.63 lbs / 49.27 kgs

Graphic

Refer to related graphic template for more information.

Visit:
www.exhibitors-handbook.com/graphic-templates

additional information:

Graphic materials:
Dye-sublimated zipper pillowcase fabric,
3mm white PVC

*Kit does not include monitor

Table colors:



silver black mahogany natural



www.display-setup-animations.com

Parts Included		
Part Label	Qty	Part Code
FABRIC GRAPHIC	x1	WV10-01-G
LN114 BOLT	x2	LN114 BOLT
90 DEGREE ELBOW JOINT FOR 30MM TUBING	x2	TC-30-90
1270MM X 30MM TUBE	x6	WV10-01-T1
30MM CURVED TUBE WITH PART T AND 90B LEFT SIDE	x1	WV10-01-T2-L
30MM CURVED TUBE WITH PART T AND 90B RIGHT SIDE	x1	WV10-01-T2-R
R2250 (1163MM ARC) CURVED TUBE	x4	WV10-01-T2
(2) 128MM TUBES SWAGED WITH PART TC-30-T	x1	WV10-01-T4
(2) 128MM TUBES SWAGED WITH PART TC-30-T	x1	WV10-01-T7
(2) 128MM TUBES SWAGED WITH PART TC-30-X	x1	WV10-01-T5
STEEL PLATE FOR WVC	x2	WVC-PLATE-STD

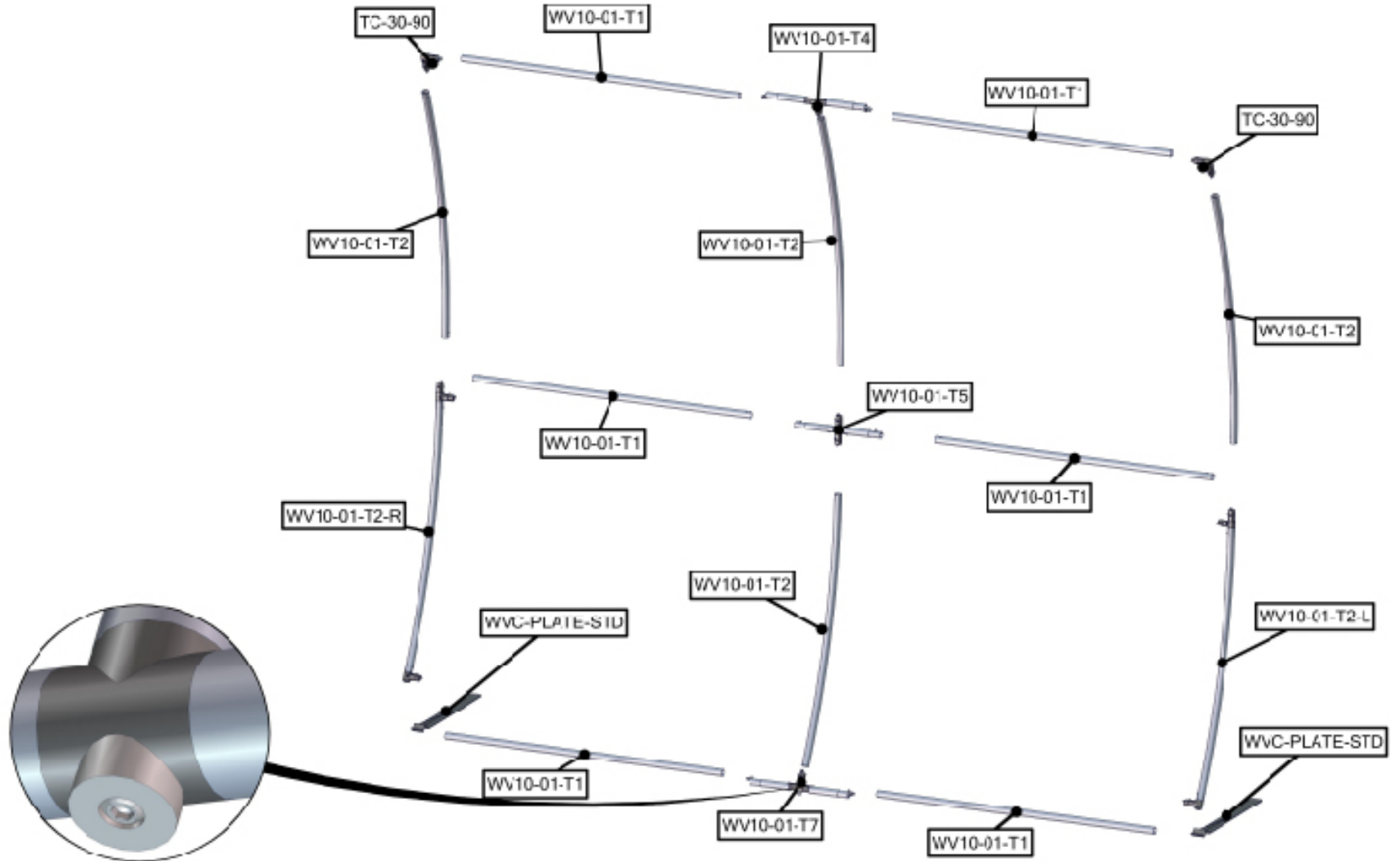

Parts Included		
Part Label	Qty	Part Code
30MM TUBE CLAMP	x2	ACC60
SMALL MONITOR BRACKET	x1	EXT-SM-MB
520 X 300 X 30 COUNTER	x1	CTWL03
PARALLEL TUBE CLAMP FOR 30MM TUBES	x2	TCP-3030
30MM TUBE SECTION	x2	WL-T3
TOP SINTRA GRAPHICS	x2	WLLH-T-G
30MM TUBE SECTION	x1	WL-T13
30MM TUBE SECTION	x1	WL-T6
30MM TUBE SECTION	x1	WL-T7
RWL-T10	x1	RWL-T10

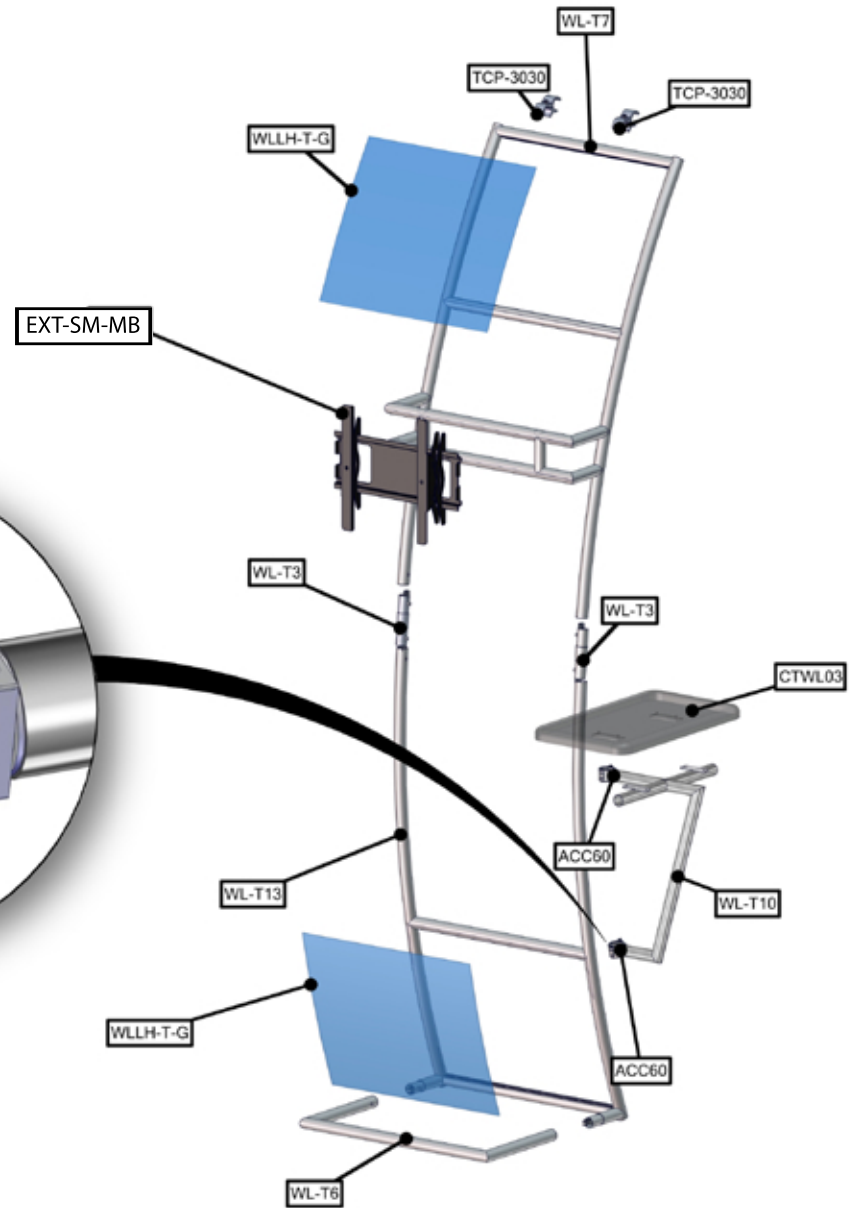
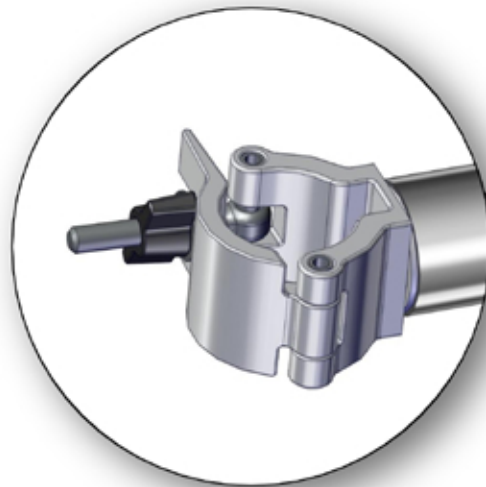

STEP 1: ASSEMBLE FRAME

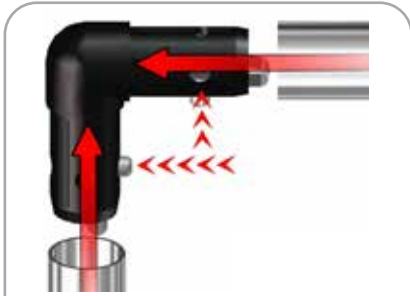

Assemble top frame corners using TC-30-90. Label codes will be on backside of tube. It is best to assemble frame laying flat.

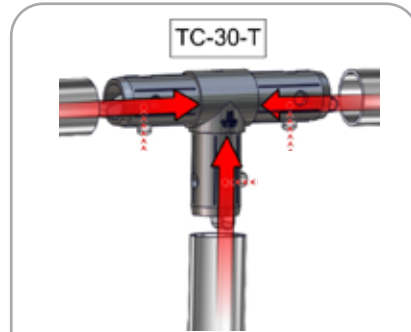

Connect sides of frame by lining up holes with snap buttons.



Use TC-30-90B to connect bottom frame corners; snap on button.

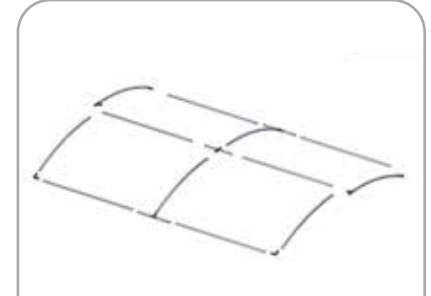

Frame assembly is complete once all sides and middle are connected.

STEP 2: ATTACH FEET

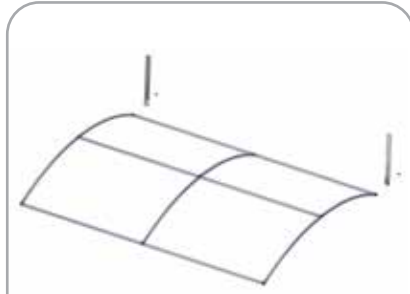

Attach feet with Allen key. See next step for detailed view.



Using provided allen key, secure both feet (WVM-BP) to bottom of frame by tightening bolt.

STEP 3: ATTACH GRAPHIC

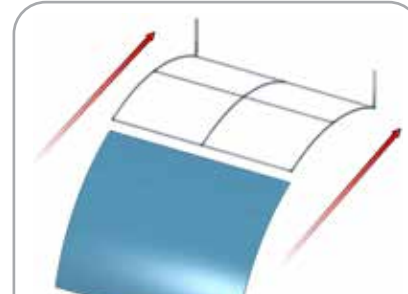

Slide graphic over top of frame.

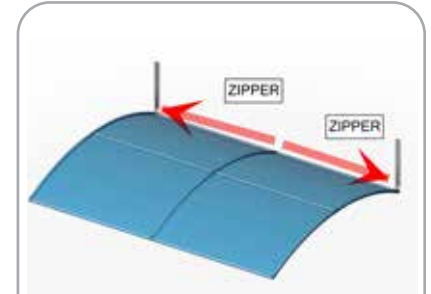

Zip fabric closed as shown along bottom.

STEP 4: ASSEMBLE LADDER FRAME

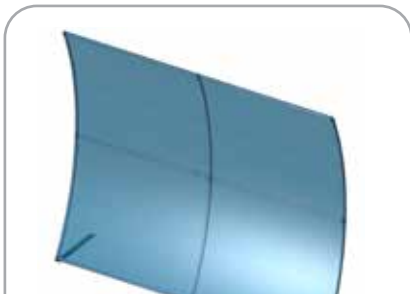

Stand unit upright.

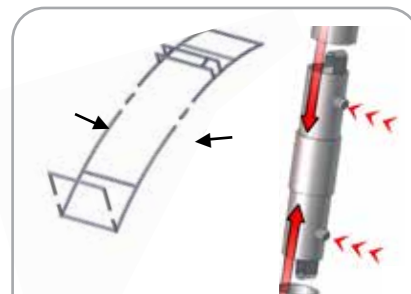

First connect top accent frame to bottom using WL-T3.

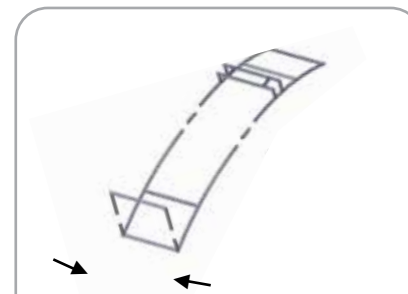

Next connect accent frame to base.

STEP 5: ATTACH TABLE TO LADDER

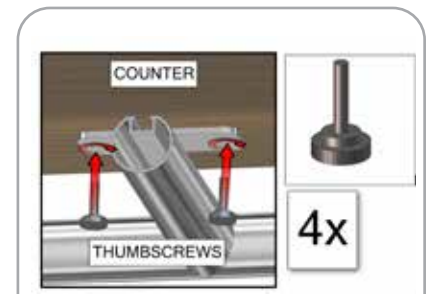

Use thumbscrews to attach table to hardware.

STEP 6: ATTACH TABLE TO ACCENT FRAME

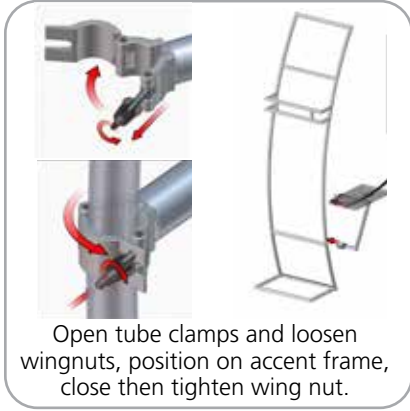

STEP 7: INSTALL MONITOR MOUNT



STEP 8: ATTACH GRAPHICS

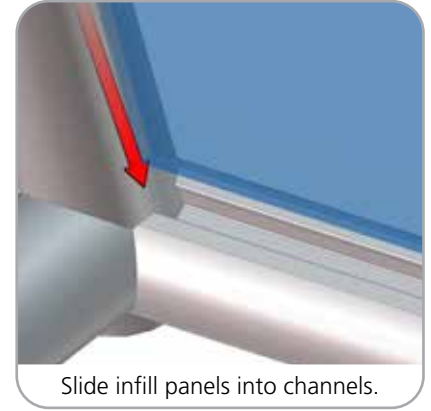

STEP 9: ATTACH TO BACKWALL WITH CLAMPS

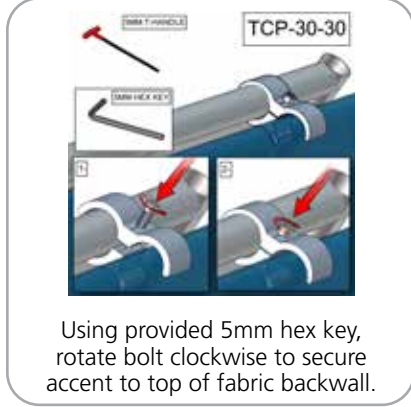
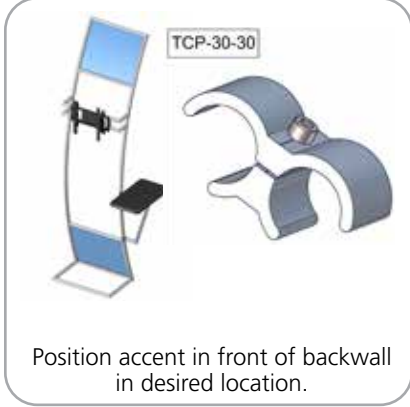

Monitor Bracket Instructions

Tube Applications



TUBE-SM-MB

Sizes: 17" - 37"

Max weight varies per application



TUBE-M-MB

Sizes: 32" - 55"

Max weight varies per application



TUBE-LG-MB

Sizes: 40" - 65"

Max weight varies per application

Included hardware:

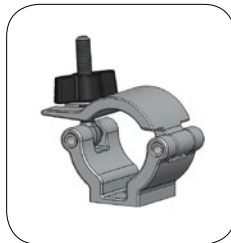

ACC60 x2



TCH-30 x2

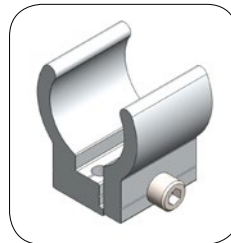

TC-30MM-SILVER x2



BOLT-1 x4

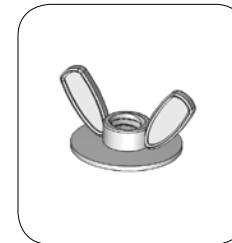

Flange Wingnut x4

TUBE CONNECTION

ACC60 Clamp Connection

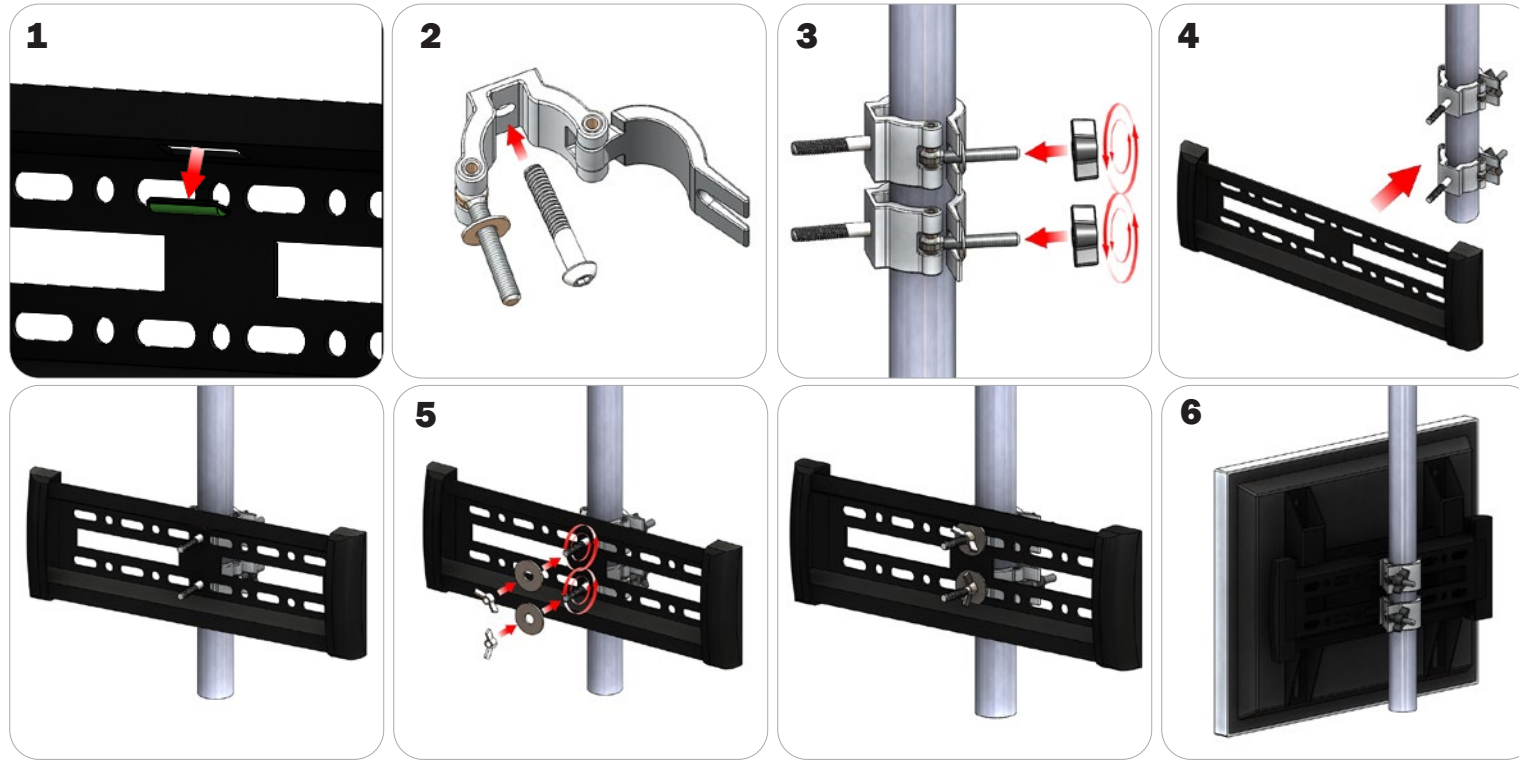

Locate all components needed to assemble the monitor mount with the ACC60 tube method. You will need (1) monitor bracket, (2) ACC60 clamps, (2) washers, and (2) wingnuts. **Step 1:** Apply pressure to the rear side of the leveling gauge clipped into the monitor mount to remove it. **Step 2:** Push the provided bolt through the hole in the ACC60 and place the ACC60 in the desired location. **Step 3:** Tighten the clamp to the tube using the plastic wingnut. **Step 4:** Set your monitor bracket onto the protruding bolts using the of the ACC60 using the center holes on the monitor bracket., adjust ACC60 position if necessary. **Step 5:** Lock your monitor bracket to the ACC60s by placing your washers and locking with provided wingnuts. **Step 6:** Reference the included manufacturer monitor mount instructions for fastening your monitor to the bracket.

TCH Clamp Connection (Tablet Stands)

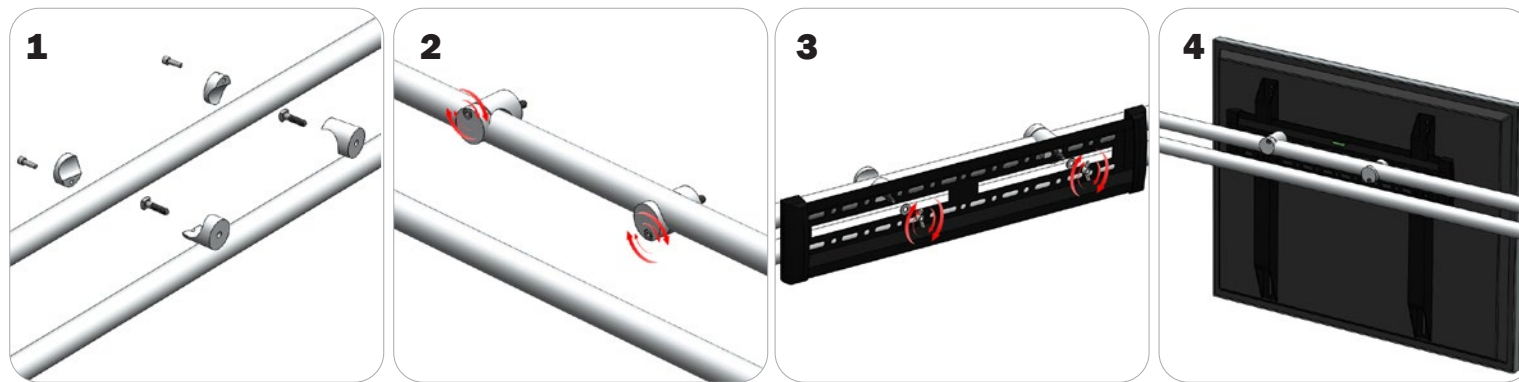

Locate all components needed to assemble the monitor mount with the TCH tube method. You will need (1) monitor bracket, (2) TCH clamps, (2) bolts, (2) washers, and (2) wingnuts. Determine your desired monitor location. **Step 1:** Fit the provided bolts through the TCH clamps then reassemble the clamp. **Step 2:** Lock the clamp onto the tube with the allen head screws on the clamp. **Step 3:** Align your monitor bracket so that the left and right holes slide onto the bolts behind them. Use your washers and wingnuts to lock your monitor bracket in place. **Step 4:** Reference the included manufacturer monitor mount instructions for fastening your monitor to the bracket.

TUBE CONNECTION

TC-30 Clamp Connection

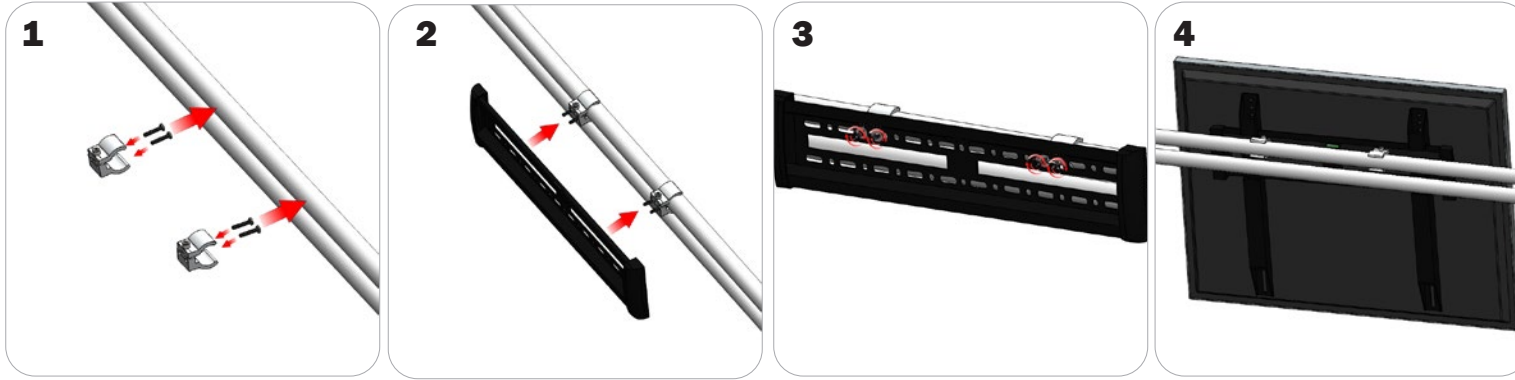

Locate all components needed to assemble the monitor mount with the TC-30 tube clamp method. You will need (1) monitor bracket, (2) TC-30-SILVER clamps, (4) BOLT-1 screws, and (4) flange wingnuts. **Step 1:** Insert the pan-head screws through the holes of your TC-30 clamps. Attach the TC-30 clamps to the tubes but do not tighten. **Step 2:** Set your monitor bracket onto the protruding pan-head screws on your clamps using the holes in the monitor bracket. **Step 3:** Apply your flange wingnuts to the front of your monitor bracket to lock it to the clamps. Lock your clamps securely into place. **Step 4:** Reference the included manufacturer monitor mount instructions for fastening your monitor to the bracket.