

Set Up Instructions

MNL-H-101018R

Step 1: Assemble all straight pipes with bungee cords by pushing and pulling together.

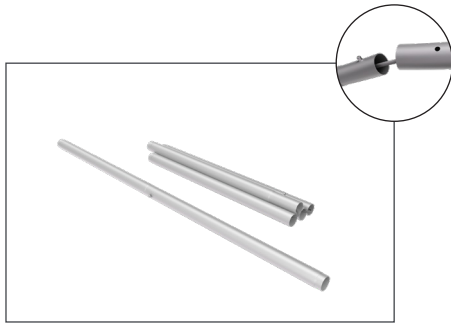

Step 2: Connect all corner sections to straight sections of the frame by matching shape symbols on pipes.

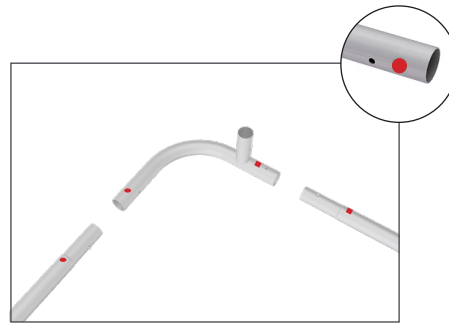

Step 3: Connect newly assembled corners and straight sections to T-Bars by matching shape symbols on pipes to build two outer frames.

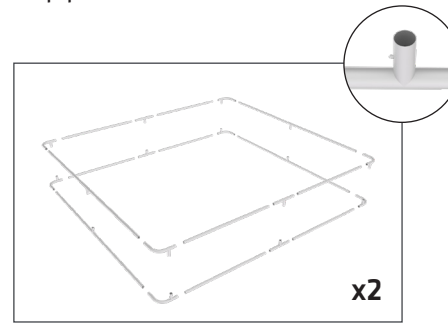

Step 4: Build center support frame by connecting T-Bars, straight pipes to center Cross Bar .

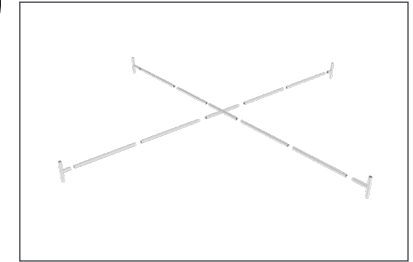

Step 5: Lay one side of frame flat and build up with center frame support, corner supports and then top frame by matching shape symbols on pipes.

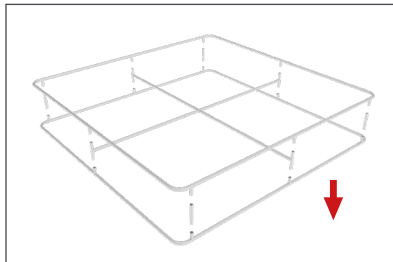

Step 6: On a clean surface with clean hands, unzip print and slide print onto frame like a pillow case.

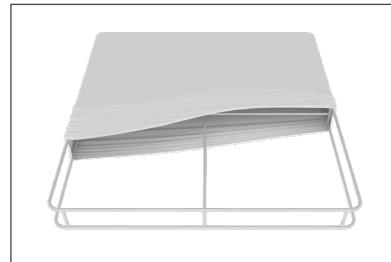

Step 7: Grip the fabric tightly and stretch around bottom of desk to pinch zipper into place. Zip the print together for taut finish.

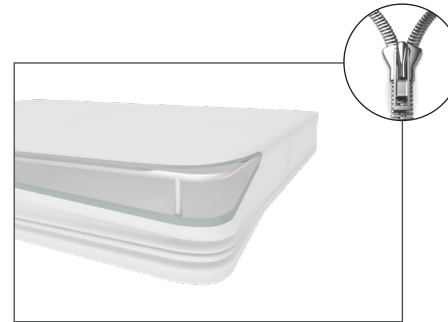

LIGHTS:
(OPTIONAL) Attach lights to top of frame by placing clear protective fabric strips inside clamp and pressing light onto the frame.

