

# Set Up Instructions

# MNL-H-102018R

**Step 1:** Assemble all straight pipes with bungee cords by pushing and pulling together.

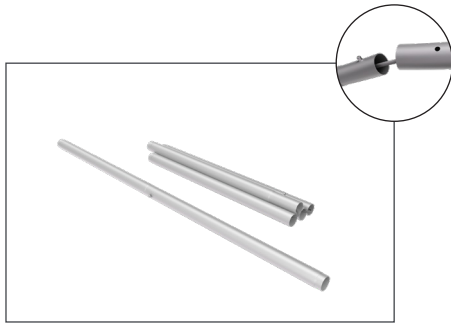

**Step 2:** Connect all corner sections to straight sections of the frame by matching shape symbols on pipes.

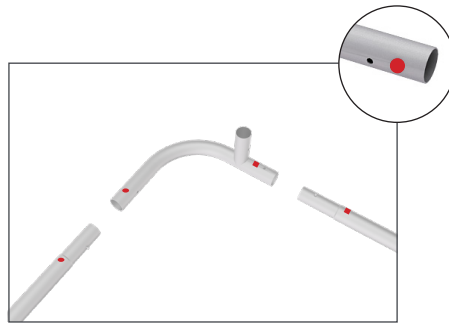

**Step 3:** Connect newly assembled corners and straight sections to T-Bars by matching shape symbols on pipes to build two outer frames.

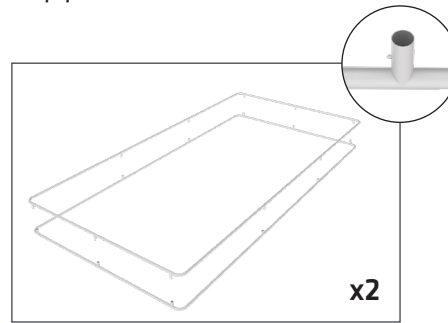

**Step 4:** Build center support frame by connecting T-Bars, straight pipes to center Cross Bar .

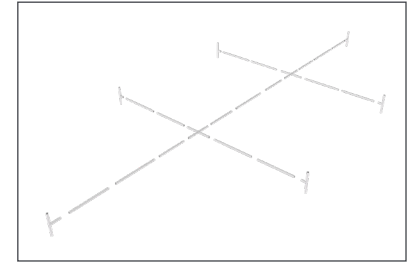

**Step 5:** Lay one side of frame flat and build up with center frame support, corner supports and then top frame by matching shape symbols on pipes.

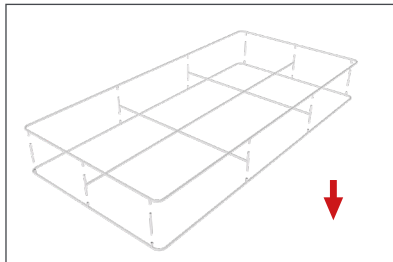

**Step 6:** On a clean surface with clean hands, unzip print and slide print onto frame like a pillow case.

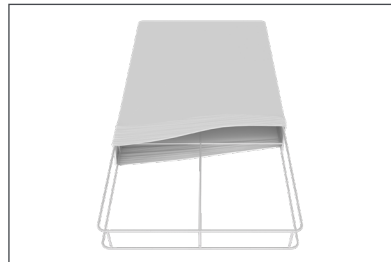

**Step 7:** Grip the fabric tightly and stretch around bottom of desk to pinch zipper into place. Zip the print together for taut finish.

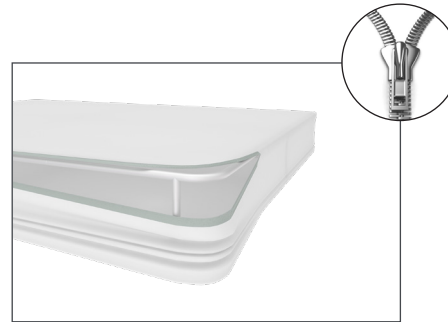

**LIGHTS:**  
(OPTIONAL) Attach lights to top of frame by placing clear protective fabric strips inside clamp and pressing light onto the frame.

