

Hercules 03

OR-K-HC03

The Hercules line of Orbital Express Truss™ features basic backwalls and kits in a variety of sizes to suit a range of space needs. A benefit to this versatile system is that it enables you to reconfigure kits in multile ways and combinations using the same parts. Simply add or detract from an Hercules kit to create a new appearance for every event or tradeshow.

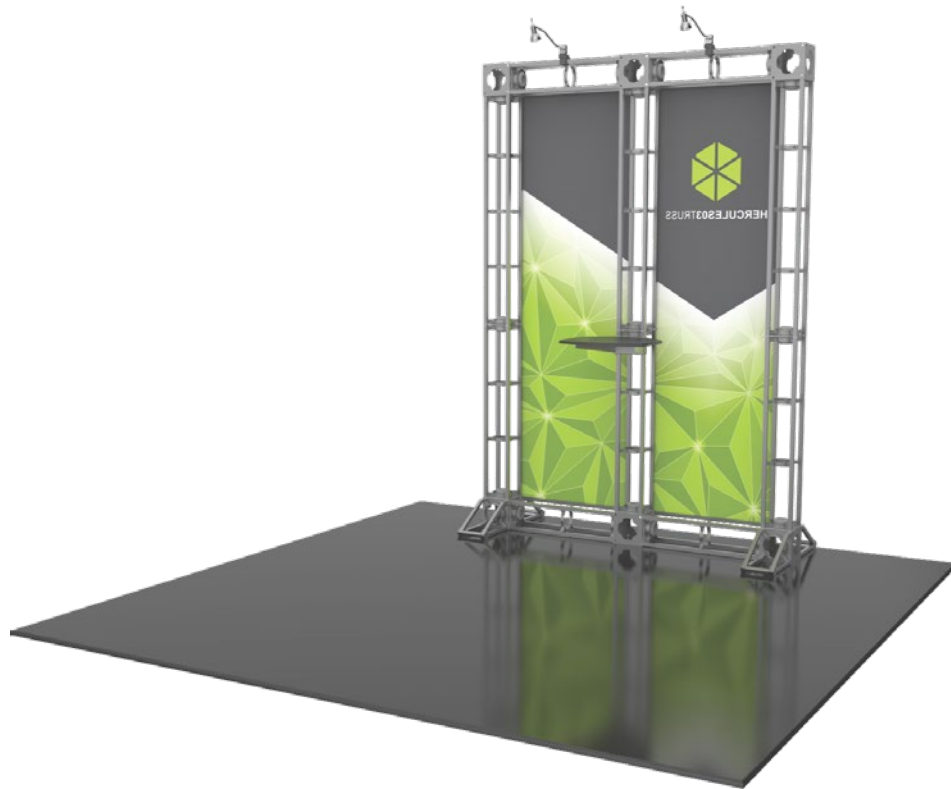

We are continually improving and modifying our product range and reserve the right to vary the specifications without prior notice. All dimensions and weights quoted are approximate and we accept no responsibility for variance. E&OE. See Graphic Templates for graphic bleed specifications.

features and benefits:

- 10' x 10' kit size
- 1 x adjustable tabletop
- Custom appearance
- Simple twist and lock design
- 5 year warranty against manufacturer defects

dimensions:

Hardware

Assembled unit:
66.75" w x 94.5" h x 33.25" d
1695mm(w) x 2400mm(h) x 845mm(d)

Graphic

Refer to related graphic template for more information.

Visit:
www.exhibitors-handbook.com/graphic-templates

Shipping

Packing case(s):
2 OCH2

Shipping dimensions:
52" l x 30" w x 15" h
1321mm(l) x 762mm(w) x 381mm(h)

Approximate total shipping weight
(includes cases & graphics):
200 lbs / 91 kg

additional information:

Graphic material:
Dye sublimated or UV panels

Lumina 1, 50 watt spotlight

Tabletop: max weight = 25 lbs / 11 kg

Table Color Options



silver

black

mahogany

natural

Included In Your Kit

Truss, Connectors, & Accessories

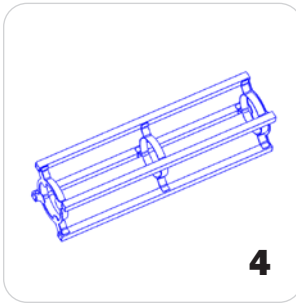

4

OR-24-2

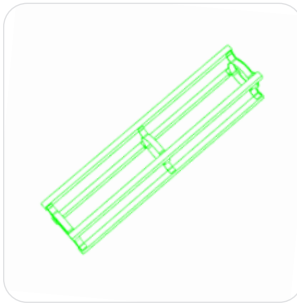

3

OR-30-2

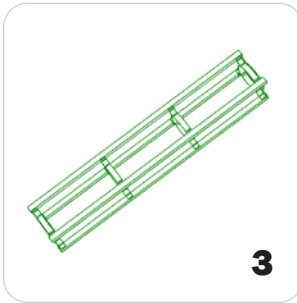

3

OR-36-2

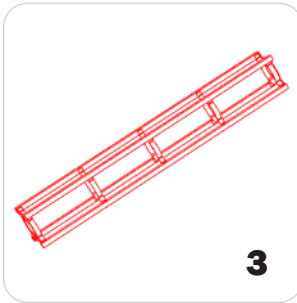

3

OR-46-2

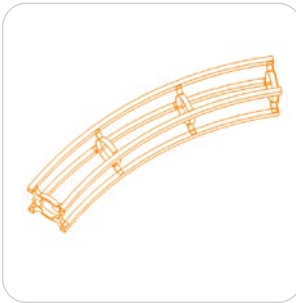

OR-45-CV-3

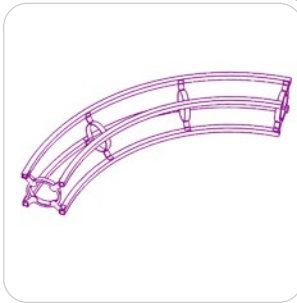

OR-90-CV-2



OR-TOOL-B

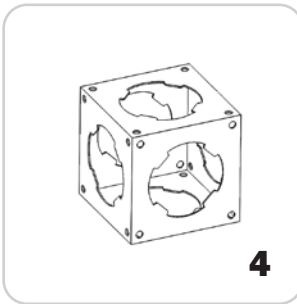

4

OR-J-3

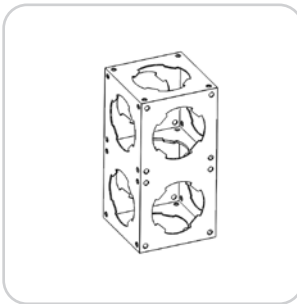

OR-J-DBL

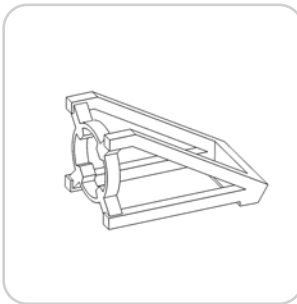

OR-B90

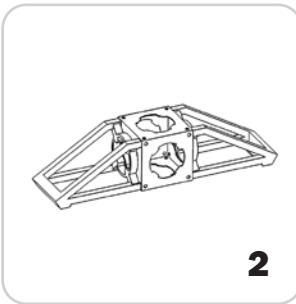

2

OR-B90A

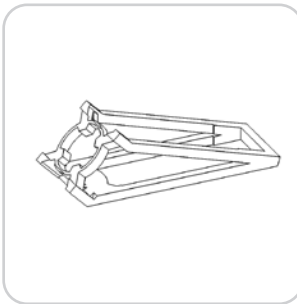

OR-B45

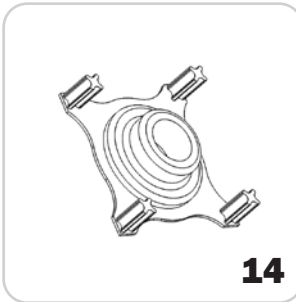

14

OR-QL-T2J

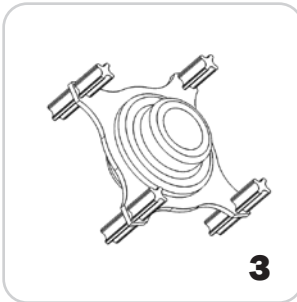

3

OR-QL-T2T



OR-UNC-QL

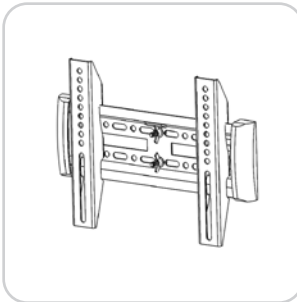

OR-SM-MB

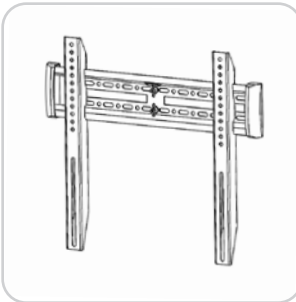

OR-M-MB

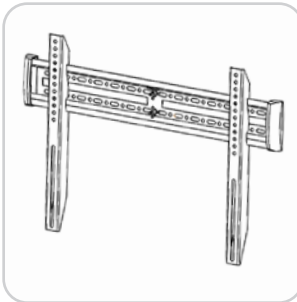

OR-LG-MB

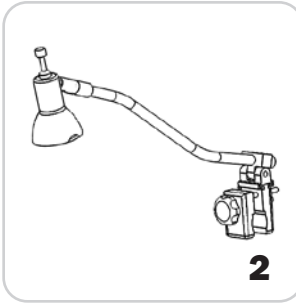

2

SPOTLIGHT

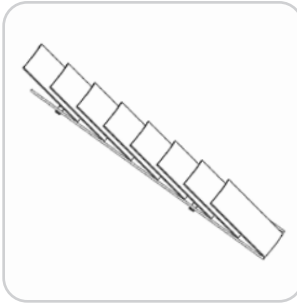

OR-STG



OR-MM-KIT

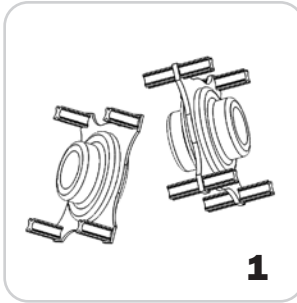

1

EXTRA PIECE SET

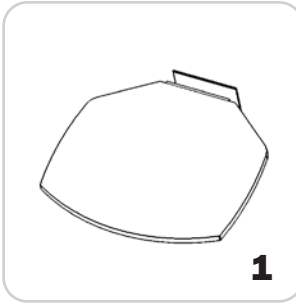

1

OR-TBL-B

Included In Your Kit

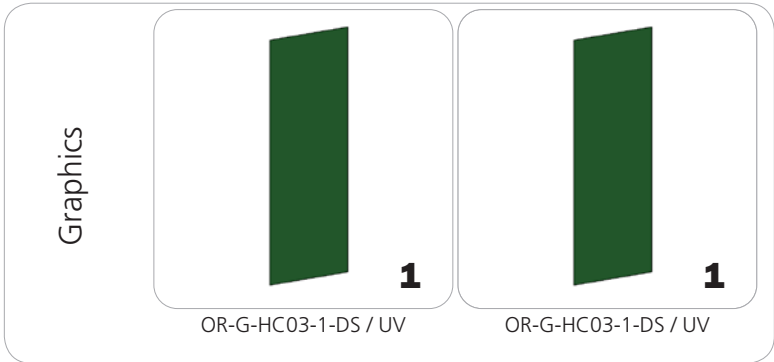

Graphics: -DS codes specify dye sublimation graphics. -UV codes specify ultra-violet graphics.

Exploded View

OR-K-HC03

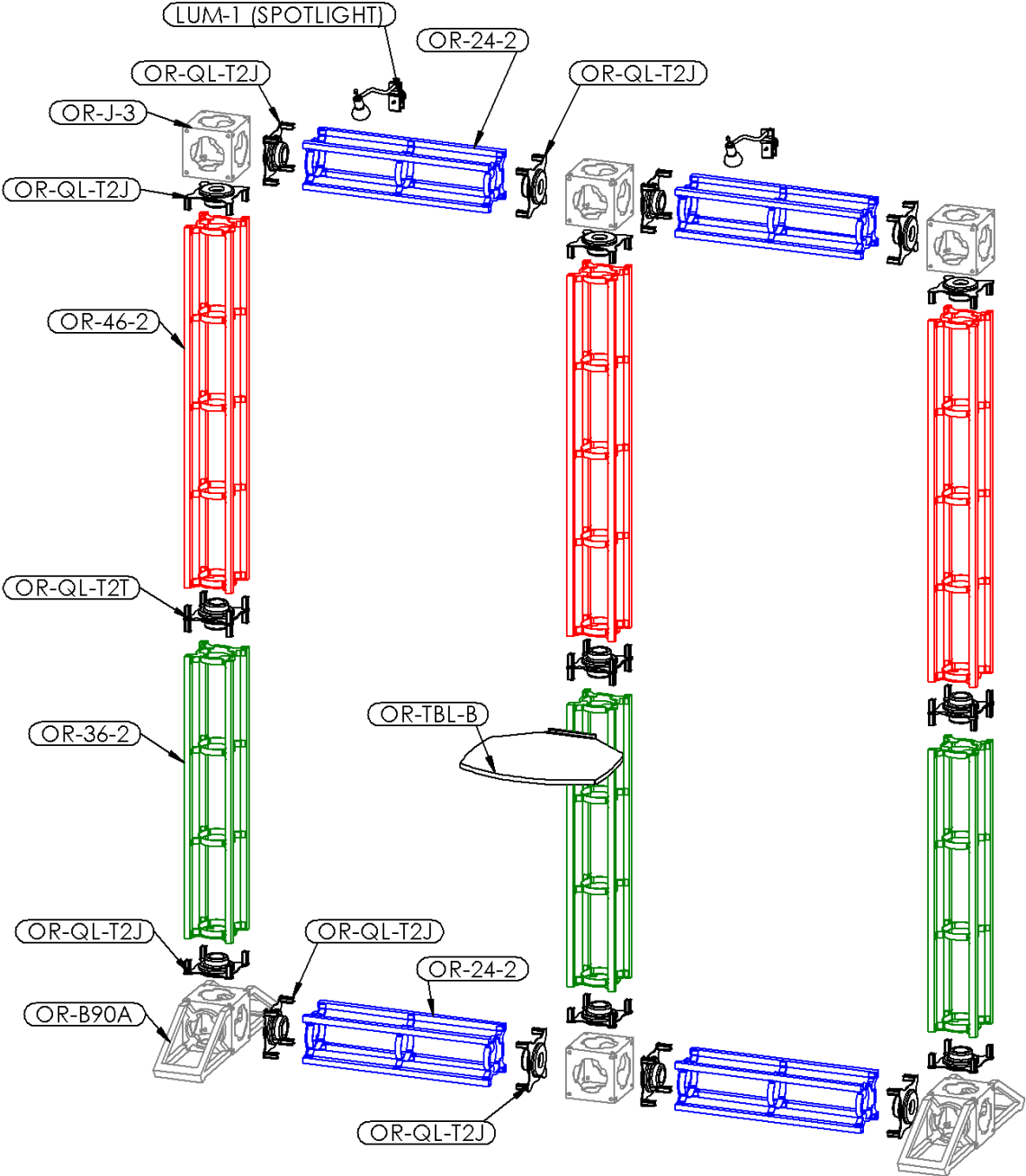

Connection Methods

Orbital Express Truss™ structures use a number of different yet simple connection methods. Your kit will include one or more of the connection methods shown below. Steps within the Kit Assembly will reference a specific method for each connection point.

Connection Method 1: Truss To Junction Box (OR-QL-T2J)

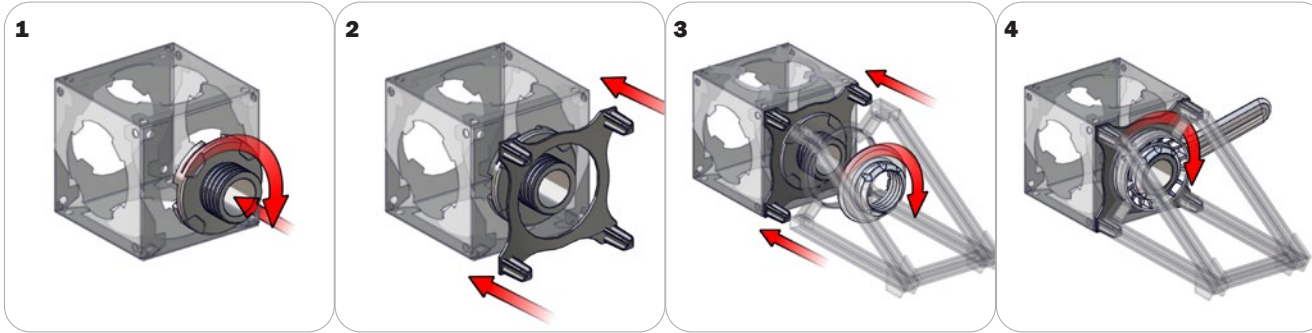

With your OR-QL-T2J (T2J) connector disassembled, insert the twist-lock hub of the connector into any large hole of the junction box and turn clockwise to lock into place (as shown in step 1). Place the bracket over the locked portion of the T2J connector so that the protruding hubs face outward (as shown in step 2). Push the truss you wish to connect onto the hubs of the T2J bracket. The hubs will slide into the holes in the end of the truss. Hand tighten the remaining cap onto the T2J connector and lock tight and securely using your OR-TOOL-B tool.

Connection Method 2: Truss To Truss (OR-QL-T2T)

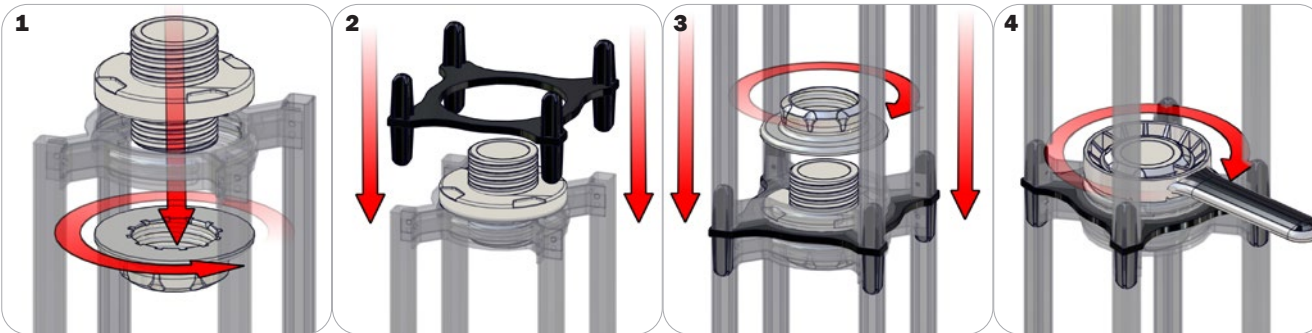

With your OR-QL-T2T (T2T) connector disassembled, assemble onto the end of your truss with the double-sided screw hub and a screw cap, then tighten with your OR-TOOL-B tool (as shown in step 1). Locate the bracket for your T2T connector. Insert the hubs of the bracket into the holes on the end of your truss. Add the truss you wish to connect by inserting the hubs of the bracket onto the second truss. Sandwich the end of the truss using the second screw cap and lock tight and securely using your OR-TOOL-B tool.

Connection Method 3: Universal Connector (OR-UNC-QL) / Accessories

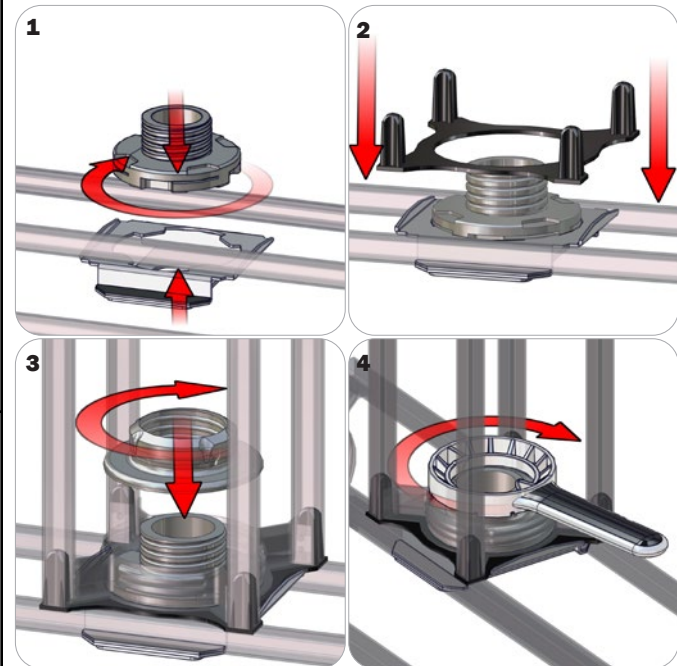

With your OR-UNC-QL (UNC) connector disassembled, assemble onto the end of the truss using the metal bracket and the screw hub. Turn clockwise to lock the bracket and twist-locking hub together. Add the plastic hub over the locked pieces so that the protruding hubs point away and the bracket sits flush. Push the truss you wish to connect onto the bracket, letting the hubs insert into the holes of the truss. Hand tighten the remaining cap onto the T2J connector and lock tight and securely using your OR-TOOL-B tool.

Kit Assembly

Step by Step

Step 1.

Assemble your truss kit according to the Exploded View. It is recommended to build your assembly from bottom to top.

Please reference Connection Methods 1 & 2 for more details.

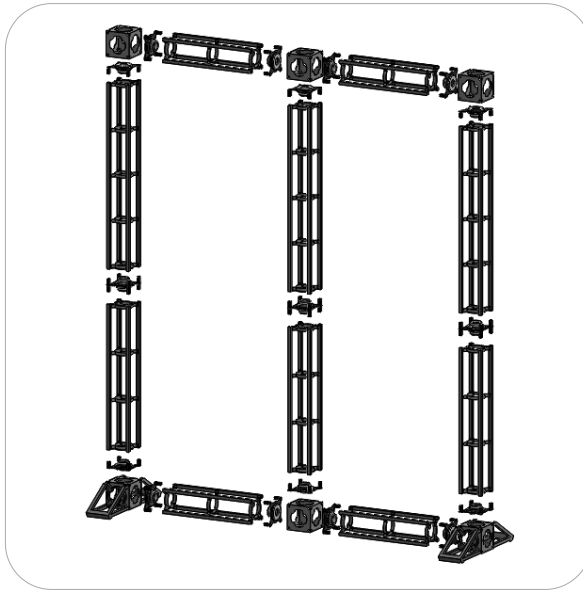
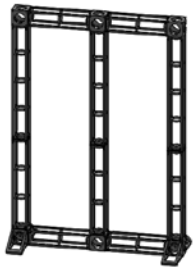

Step 2.

If your kit features "Dye Sublimation" fabric graphics, apply the hook velcro around the border of the truss you wish to apply your graphic to. Apply the graphic utilizing the presewn loop velcro on its unprinted side. If your kit features "UV panel" graphics, simply attach the graphic to the truss utilizing the preapplied magnets.

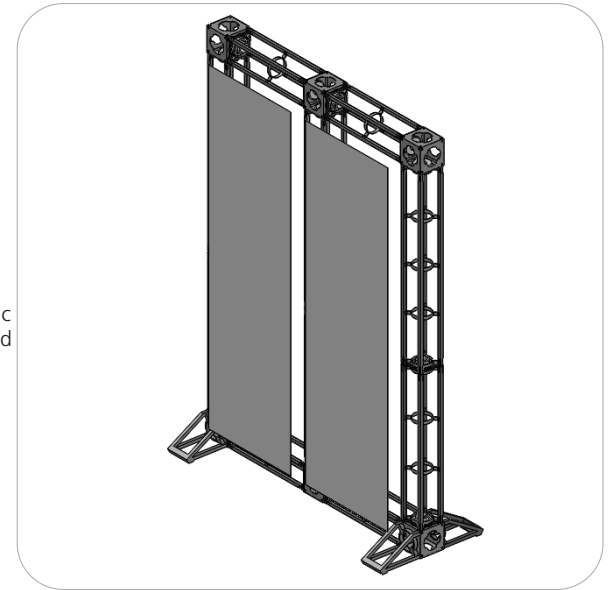
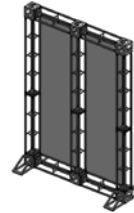

Step 3.

Slide the "Universal" clamp style light connector to your spotlights. Open your clamps using the adjustment knob. Apply the light assembly in the desired position and clamp tightly into place.

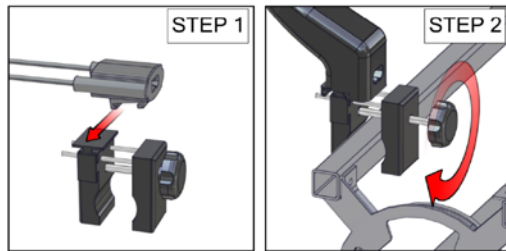

1- Slide light onto UNIVERSAL CLAMP
2-Then attach Light on top of the frame.
Up to 30mm

Step 4.

Install your OR-TBL table onto your kit. Undo the metal clamp and reassemble with truss between.

Setup complete.

